

2021

€ **FİYAT LİSTESİ**

5 / Basınç Ölçerler

31 / Basınç Aksesuarları

33 / Sıcaklık Ölçerler

Fiyatlarımıza K.D.V. dahil değildir.

Ödeme vadesi 60 (altmış) gündür.

Bu fiyat listesi en güncel bilgileri sunmaktadır.

PAKKENS mamullerin ve fiyatların üzerinde önceden bildirmeden her türlü değişiklik yapma hakkını saklı tutar.

İÇİNDEKİLER

| | |
|----|---|
| 2 | Hakkımızda |
| 3 | Basınç Ölçer Seçimi |
| 5 | Basınç Ölçerler |
| 6 | MG Serisi Genel Amaçlı Basınç Ölçerler |
| 9 | MG Serisi Genel Amaçlı, Gliserin Dolgulu Basınç Ölçerler |
| 11 | MH Serisi Hassas Basınç Ölçerler |
| 12 | MH Serisi Hassas, Sıvı Dolgulu Basınç Ölçerler |
| 13 | MH Serisi Hassas, Komple Paslanmaz Basınç Ölçerler |
| 14 | MH Serisi Hassas, Komple Paslanmaz, Sıvı Dolgulu Basınç Ölçerler |
| 15 | MH Serisi Hassas, Solid Front Basınç Ölçerler |
| 16 | MK Serisi Kontaklı, Hassas Basınç Ölçerler |
| 16 | MK Serisi Kontaklı, Silikon Dolgulu, Hassas Basınç Ölçerler |
| 17 | MK Serisi Kontaklı, Komple Paslanmaz, Hassas Basınç Ölçerler |
| 17 | MK Serisi Kontaklı, Komple Paslanmaz, Silikon Dolgulu, Hassas Basınç Ölçerler |
| 18 | MT Serisi Basınç Sensörleri (Manotransmitterler, Transmitterler) |
| 19 | MC Serisi Kapsül Diyaframlı Basınç Ölçerler |
| 20 | MC Serisi Kapsül Diyaframlı, Sıvı Dolgulu Basınç Ölçerler |
| 21 | MC Serisi Kapsül Diyaframlı, Komple Paslanmaz Basınç Ölçerler |
| 21 | MC Serisi Kapsül Diyaframlı, Komple Paslanmaz, Sıvı Dolgulu Basınç Ölçerler |
| 22 | DG Serisi Fark Basınç Ölçerler |
| 23 | U Manometre |
| 24 | DS Serisi Diyafram Ayırıcılı Hassas Basınç Ölçerler |
| 27 | SH Serisi Schaeffer Tip Hassas Basınç Ölçerler |
| 28 | MH Serisi Master Basınç Ölçerler |
| 28 | Kalibrasyon Hizmetleri |
| 29 | Manifoldlar |
| 31 | Basınç Aksesuarları |
| 33 | Sıcaklık Ölçerler |
| 34 | TE Serisi Bi-metal Sıcaklık Ölçerler |
| 35 | TB Serisi Komple Paslanmaz Bi-Metal Sıcaklık Ölçerler |
| 36 | TB Serisi Komple Paslanmaz Sızdırmaz Tip Bi-Metal Sıcaklık Ölçerler |
| 37 | TB Serisi Komple Paslanmaz Sıvı Dolgulu Bi-Metal Sıcaklık Ölçerler |
| 38 | TG Serisi Komple Paslanmaz Gazlı Sıcaklık Ölçerler |
| 39 | TG Serisi Komple Paslanmaz Gazlı Hassas Sıcaklık Ölçerler |
| 40 | TK Serisi Kontaklı, Gazlı Sıcaklık Ölçerler |
| 41 | TK Serisi Komple Paslanmaz, Kontaklı, Gazlı, Hassas Sıcaklık Ölçerler |
| 42 | TI Serisi Gazlı, Genel Amaçlı Sıcaklık Ölçerler |
| 43 | TI Serisi Kombine Ölçerler |
| 44 | Termoviller |

Hakkımızda

PAKKENS, 45 yılı aşkın bir süredir her türlü basınç ve sıcaklık ölçüm cihazlarının, HVAC ve tesisat ürünlerinin, ısıtma sektörü için hidrolik grupların ve müşteriye özel hassas talaşlı imalat parçalarının tasarım ve üretimini gerçekleştiren, alanının lider firmasıdır.

Firma, Bursa Organize Sanayi Bölgesindeki tam entegre iki üretim tesisinde toplam 450 nin üzerinde yetkin personeli ile petro-kimya, gaz dağıtım, ilaç, biyoteknoloji, gıda işleme, HVAC, makine imalatı, hidrolik, tarım, inşaat, otomotiv, savunma ve havacılık vb. sektörlerdeki ana sanayi firmaları ve son kullanıcılara hizmet vermektedir.

Ölçüm cihazları portföyü, standart ve yüksek hassasiyetli endüstriyel basınç ölçerler, kontaklı tip basınç ölçerler, çıkış sinyalli basınç ölçerler, diferansiyel basınç ölçerler, diyafram ayırıcılı basınç ölçerler, kapsül diyaframlı basınç ölçerler, emniyet plakalı basınç ölçerler, basınç transmitterleri, bi-metal ve gazlı tip termometreler, kombine ölçerler, valf ve manifoldlar, termoviller, enstrümantasyon aksesuarları ve kalibrasyon hizmetlerinden oluşur.



PAKKENS®

- ✓ Ölçüm cihazları alanında Türkiye'de pazar lideridir.
- ✓ Türkiye'nin ilk ve en gelişmiş basınç ölçer kalibrasyon laboratuvarına sahiptir.
- ✓ Portföyünde 15.000 adedin üzerinde standart ve müşteriye özel ürün bulundurmaktadır.
- ✓ Sınıfının en iyisi ürünleri en makul fiyat seviyelerinde üretmek için gerekli, çok iyi yapılmış tasarım, üretim, kalite, planlama ve lojistik süreçlerine sahiptir.
- ✓ Ürünlerini gerçekleştirmek için en gelişmiş üretim ve test teknolojilerini kullanmaktadır.
- ✓ Konsept tasarımdan seri üretime kadar tüm süreçleri bünyesinde barındıran tam entegre bir şirkettir.
- ✓ ISO 9001:2015, ISO 14001:2015, OHSAS 18001:2007 ve AS9100 Rev.D kalite sistem sertifikalarına ve ürünlerinin yurtdışı pazarlarda satışı için gerekli tüm ürün sertifikasyonlarına sahiptir.



Basınç Ölçer Seçimi

İhtiyacınıza en uygun basınç ölçerin seçiminde aşağıdaki hususları dikkate almanız önerilir:



Basınç ölçümü yapılacak akışkanın bileşimi

Basınç ölçerinizin duyar elemanı doğrudan ölçüm yapılacak akışkanın içinde yer alabileceği için, akışkanın özellikleri önemlidir. Akışkanlar aşındırıcı ya da kolay kristalleşebilen özellikte olabilirler ya da ölçüm elemanı üzerinde kalıntı bırakabilirler. Normal koşullar altında kristalleşmeyecek ya da kalıntı bırakmayacak sıvılar söz konusu olduğunda, Bourdon tüplü bir basınç ölçer kullanılabilir. Diğer koşullarda ise diyafram ayırıcılı ürünler tercih edilmelidir.

Basınç ölçümü yapılacak akışkanın sıcaklığı

Buhar ya da yüksek sıcaklıktaki diğer akışkanlar, cihaz bileşenlerinin sıcaklıklarını sızdırmazlık elemanları için güvenli kabul edilen düzeylerin üzerine çıkarabilir. Bunun gibi durumlarda, basınç ölçer ile birlikte bir sifon, soğutma kulesi ya da diyafram kullanılması önerilir.

Çevre koşulları

Ölçüm cihazı seçimi sırasında, nem ve iklim koşullarının etkileri de göz önünde bulundurulmalıdır. Çok yüksek ortam sıcaklıklarından kaynaklanabilecek ölçüm hataları, ölçüm cihazının bir diyafram ayırıcı ve kapiler boru kullanılarak ısı kaynağından uzağa monte edilmesi ile engellenebilir.

Basınç aralığı

EN837-2'ye göre manometre kullanılması planlanan bir sistemin maksimum kararlı çalışma basıncı, manometrenin tam skala değerinin %75'i olmalıdır.

Ancak, basınç dalgalanması olan bir sistemin maksimum çalışma basıncı, manometrenin tam skala değerinin %65'i olmalıdır.

Bunun yanı sıra tahdit pimli manometrelerin tam skalasının %10 ile %75'i arasında doğru ölçüm aralığına sahip olduğu, tahdit pimsiz manometrelerin ise tam skalalarında doğru ölçümler için kullanılabileceği unutulmamalıdır.



Sistemin aşınmasını etkileyen koşullar

Şiddetli basınç dalgalanmaları ya da yoğun titreşim içeren uygulamalarda, basınç sınırlayıcı ya da düşürücü aksesuarlar kullanılması önerilir. Sıvı dolgulu basınç ölçerler de yine bu tip koşullarda daha uzun ömürlü olacaklardır. **PAKKENS** sıvı dolgulu basınç ölçerleri genellikle gliserin ile doldurulurlar. Ürün gamında daha geniş bir sıcaklık aralığında çalışma gereksinimi için silikon dolgulu basınç ölçerler de bulunmaktadır.



Bağlantı yöntemi

Birçok **PAKKENS** ölçüm cihazının Alttan ya da Arkadan bağlantılı versiyonları mevcuttur. Standart olarak sunulan dış tipleri dışında, **PAKKENS** birçok ürünü için farklı dış tipi/ölçüsü seçenekleri de sunmaktadır.

Basınç ölçerlerin normal şartlarda her zaman dik olarak bağlanması gerektiği unutulmamalıdır. Bağlantının yatay veya baş aşağı olarak yapılmasının zorunlu olduğu durumlarda, satış bölümümüz ile görüşülmesi önerilir.



Hassasiyet sınıfı

PAKKENS, %+-0,25 den %+-2,5 a kadar farklı hassasiyet sınıflarında basınç ölçerler üretmektedir. Uygulamanız için en iyi sonucu almanız, doğru hassasiyete sahip bir cihaz seçimi ile mümkün olabilir.

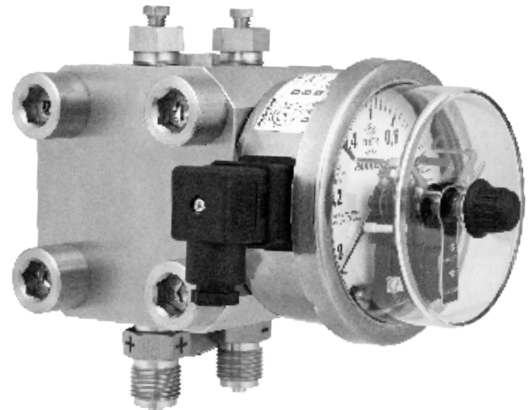

Yukarıda bahsedilen cihaz seçim faktörleri, ölçüm cihazınızın güvenli bir şekilde ve ihtiyaç duyulan doğrulukta çalışabilmesi için önemlidir. Cihaz seçimi konusunda şüpheye düşmeniz halinde satış bölümümüz ile temasa geçebilirsiniz.





BASINÇ

ÖLÇERLER

| | | | | | | | |
|------------|----------------|-------------------|--|------------------|---|-------------------------------|--|
| Ø40 | Cl. 2,5 | MANOMETRE | 0/1..1,6..2,5..4..6..10..16..25..40..60..100..160..250..315..400 bar | (bar/psi) | 040 100 <input type="checkbox"/> | Basınç Elemanı: Bakır Alaşımı | |
| | G 1/8" | VAKUMMETRE | -760/0 mmHg -1/0 bar Manovakummetre: -1/+0,6..1,5..3..5..9..15..24 bar | (mmHg) (bar/psi) | 040 200 <input type="checkbox"/> | Bağlantı Elemanı: Piriç | |
| | IP41 | HİDROMETRE | 0/10..16..25..40..60..100 mWS | (mWS/bar) | 040 300 <input type="checkbox"/> | Mekanizma : Piriç | |



Metal Gövde
Akrilik Kapak
-1...60 bar
€4,60
100...400 bar
€4,75

Bağlantı Tipi No : - - - - - **01**
Alttan Bağlantılı



Plastik Gövde
Akrilik Kapak
-1...60 bar
€4,40
100...400 bar
€4,50

Bağlantı Tipi No : - - - - - **02**
Arkadan Bağlantılı



Metal Gövde
Akrilik Kapak
-1...60 bar
€4,50
100...400 bar
€4,60

Bağlantı Tipi No : - - - - - **02**
Arkadan Bağlantılı



Metal Gövde
Metal Kapak
-1...60 bar
€5,30
100...400 bar
€5,40

Bağlantı Tipi No : - - - - - **03**
Arkadan Bağlantılı Pano Tip



2 bar Kirlilik Göstergesi
Ürün Kodu : **040 100 02 03 10**
Arkadan Bağlantılı



4 bar Kapiler Borulu (G1/4" - 1 mt)
Ürün Kodu : **040 100 09 05 10**
Arkadan Bağlantılı

| | | | | | | | |
|------------|----------------|-------------------|---|------------------|---|-------------------------------|--|
| Ø50 | Cl. 2,5 | MANOMETRE | 0/0,6..1.1,6..2,5..4..6..10..16..25..40..60..100..160..250..315..400..600 bar | (bar/psi) | 050 100 <input type="checkbox"/> | Basınç Elemanı: Bakır Alaşımı | |
| | G 1/4" | VAKUMMETRE | -760/0 mmHg -1/0 bar Manovakummetre: -1/+0,6..1,5..3..5..9..15..24 bar | (mmHg) (bar/psi) | 050 200 <input type="checkbox"/> | Bağlantı Elemanı: Piriç | |
| | IP41 | HİDROMETRE | 0/6..10..16..25..40..60..100 mWS | (mWS/bar) | 050 300 <input type="checkbox"/> | Mekanizma : Piriç | |



Plastik Gövde
Akrilik Kapak
-1...60 bar
€3,75
100...600 bar
€4,00

Bağlantı Tipi No : - - - - - **01**
Alttan Bağlantılı



Metal Gövde
Akrilik Kapak
-1...60 bar
€3,90
100...600 bar
€4,10

Bağlantı Tipi No : - - - - - **01**
Alttan Bağlantılı



Plastik Gövde
Akrilik Kapak
-1...60 bar
€4,55
100...600 bar
€4,80

Bağlantı Tipi No : - - - - - **02** **G 1/8"**
Arkadan Bağlantılı



Metal Gövde
Akrilik Kapak
-1...60 bar
€4,75
100...600 bar
€5,00

Bağlantı Tipi No : - - - - - **02** **G 1/8"**
Arkadan Bağlantılı



Metal Gövde
Metal Kapak
-1...60 bar
€5,50
100...600 bar
€5,75

Bağlantı Tipi No : - - - - - **03** **G 1/8"**
Arkadan Bağlantılı Pano Tip

STANDART

Ø63

| | | | |
|--------|------------|---|------------------|
| CL 2,5 | MANOMETRE | 0/0,6..1.1,6..2,5..4..6..10..16..25..40..60..100..160..250..315..400..600 bar | (bar/psi) |
| G 1/4" | VAKUMMETRE | -760/0 mmHg -1/0 bar Manovakummetre: -1/+0,6..1,5..3..5..9..15..24 bar | (mmHg) (bar/psi) |
| IP41 | HİDROMETRE | 0/6..10..16..25..40..60..100 mWS | (mWS/bar) |

063 100

Basınç Elemanı: Bakır Alaşımı

063 200

Bağlantı Elemanı: Piriç

063 300

Mekanizma : Piriç



Metal Gövde
Akrilik Kapak
-1...60 bar
€4,00
100...600 bar
€4,20



Plastik Gövde
Akrilik Kapak
-1...60 bar
€3,80
100...600 bar
€4,00



Metal Gövde
Metal Kapak
-1...60 bar
€4,85
100...600 bar
€5,00

Bağlantı Tipi No : - - - - - 01
Alttan Bağlantılı



Bağlantı Tipi No : - - - - - 01
Alttan Bağlantılı



Bağlantı Tipi No : - - - - - 01
Alttan Bağlantılı



Metal Gövde
Akrilik Kapak
-1...60 bar
€4,70
100...600 bar
€4,90



Plastik Gövde
Akrilik Kapak
-1...60 bar
€4,65
100...600 bar
€4,85



Metal Gövde
Metal Kapak
-1...60 bar
€5,80
100...600 bar
€5,95

Bağlantı Tipi No : - - - - - 02
Arkadan Bağlantılı



Bağlantı Tipi No : - - - - - 02
Arkadan Bağlantılı



Bağlantı Tipi No : - - - - - 02
Arkadan Bağlantılı



Metal Gövde
Metal Kapak
-1...60 bar
€5,80
100...600 bar
€5,95



Metal Gövde
Akrilik Kapak
600 mbar
€5,00

Bağlantı Tipi No : - - - - - 03
Arkadan Bağlantılı Pano Tip



Ürün Kodu : 063 100 01 18 12
Alttan Bağlantılı



Ø100

| | | | |
|--------|------------|---|------------------|
| CL 2,5 | MANOMETRE | 0/0,6..1.1,6..2,5..4..6..10..16..25..40..60..100..160..250..315..400..600 bar | (bar/psi) |
| G 1/2" | VAKUMMETRE | -760/0 mmHg -1/0 bar Manovakummetre: -1/+0,6..1,5..3..5..9..15..24 bar | (mmHg) (bar/psi) |
| IP41 | HİDROMETRE | 0/6..10..16..25..40..60..100 mWS | (mWS/bar) |

100 100

Basınç Elemanı: Bakır Alaşımı

100 200

Bağlantı Elemanı: Piriç

100 300

Mekanizma : Piriç



Metal Gövde
Metal Kapak
-1...60 bar
€8,65
100...600 bar
€8,90



Metal Gövde
Akrilik Kapak
-1...60 bar
€6,85
100...600 bar
€7,10



Metal Gövde
Metal Kapak
-1...60 bar
€8,35
100...600 bar
€8,55

Bağlantı Tipi No : - - - - - 01
Alttan Bağlantılı



Bağlantı Tipi No : - - - - - 01
Alttan Bağlantılı



Bağlantı Tipi No : - - - - - 02
Arkadan Bağlantılı

G 1/4"



**Hidrometre
İkaz İbrelisi**
(0/6..100 mWS/bar)
Metal Gövde
Akrilik Kapak
€7,25

Bağlantı Tipi No : - - - - - 01
Alttan Bağlantılı



STANDART

Ø160

CL. 1,6

G 1/2"

IP65

MANOMETRE

0/1..1,6..2,5..4..6..10..16..25..40..60..100..160..250..315..400..600 bar

bar/psi

160 100

Gövde: AISI 304 SS

Kapak: AISI 304 SS

Basınç Elemanı: Bakır Alaşımı

Bağlantı Elemanı: Pirinç

Mekanizma : Pirinç



VAKUMMETRE

-760/0 mmHg -1/0 bar Manovakummetre: -1/+0,6..1,5..3..5..9..15..24 bar

mmHg

bar/psi

160 200



Kuru Tip

0...6 bar
-1...5 bar

€29,70

Bağlantı Tipi No : - - - - - 71 Doldurulamaz
Alttan Bağlantılı

Doldurulabilir Tip

10...60 bar
-1/9...24 bar

€28,10

100...600 bar

€28,80

Bağlantı Tipi No : - - - - - 21

Alttan Bağlantılı



GLİSERİN DOLGULU

| | | | | | | | | |
|-----|---------|------------|--|--------------|---------|--------------------------|-------------------------------|--|
| Ø40 | Cl. 2,5 | MANOMETRE | 0/1..1,6..2,5..4..6..10..16..25..40..60..100..160..250..315..400 bar | bar/psi | 040 100 | <input type="checkbox"/> | Gövde: AISI 304 SS | |
| | G 1/8" | VAKUMMETRE | -760/0 mmHg -1/0 bar Manovakummetre: -1/+0,6..1,5..3..5..9..15..24 bar | mmHg bar/psi | 040 200 | <input type="checkbox"/> | Kapak: AISI 304 SS | |
| | IP67 | | | | | | Basınç Elemanı: Bakır Alaşımı | |
| | | | | | | | Mekanizma : Piriç | |



-1...400 bar
€10,70

Bağlantı Tipi No : - - - - - 12
Arkadan Bağlantılı

| | | | | | | | | |
|-----|---------|------------|--|--------------|---------|--------------------------|-------------------------------|--|
| Ø50 | Cl. 2,5 | MANOMETRE | 0/0,6..1..1,6..2,5..4..6..10..16..25..40..60..100..160..250..315..400..600 bar | bar/psi | 050 100 | <input type="checkbox"/> | Gövde: AISI 304 SS | |
| | G 1/4" | VAKUMMETRE | -760/0 mmHg -1/0 bar Manovakummetre: -1/+0,6..1,5..3..5..9..15..24 bar | mmHg bar/psi | 050 200 | <input type="checkbox"/> | Kapak: AISI 304 SS | |
| | IP65 | | | | | | Basınç Elemanı: Bakır Alaşımı | |
| | | | | | | | Bağlantı Elemanı: Piriç | |
| | | | | | | | Mekanizma : Piriç | |



-1...60 bar
€7,50

100...600 bar
€7,60

Bağlantı Tipi No : - - - - - 11
Alttan Bağlantılı



-1...60 bar
€10,20

100...600 bar
€10,35

Bağlantı Tipi No : - - - - - 12
Arkadan Bağlantılı



-1...60 bar
€10,90

100...600 bar
€11,10

Bağlantı Tipi No : - - - - - 13
Arkadan Bağlantılı Panotip

| | | | | | | | | |
|-----|---------|------------|--|--------------|---------|--------------------------|-------------------------------|--|
| Ø63 | Cl. 2,5 | MANOMETRE | 0/0,6..1..1,6..2,5..4..6..10..16..25..40..60..100..160..250..315..400..600 bar | bar/psi | 063 100 | <input type="checkbox"/> | Gövde: AISI 304 SS | |
| | G 1/4" | VAKUMMETRE | -760/0 mmHg -1/0 bar Manovakummetre: -1/+0,6..1,5..3..5..9..15..24 bar | mmHg bar/psi | 063 200 | <input type="checkbox"/> | Kapak: AISI 304 SS | |
| | IP65 | | | | | | Basınç Elemanı: Bakır Alaşımı | |
| | | | | | | | Bağlantı Elemanı: Piriç | |
| | | | | | | | Mekanizma : Piriç | |



-1...60 bar
€6,65

100...600 bar
€6,85

Bağlantı Tipi No : - - - - - 11
Alttan Bağlantılı



-1...60 bar
€8,25

100...600 bar
€8,45

Bağlantı Tipi No : - - - - - 12
Arkadan Bağlantılı



-1...60 bar
€9,55

100...600 bar
€9,70

Bağlantı Tipi No : - - - - - 13
Arkadan Bağlantılı Pano Tip

| | | | | | | | | |
|------|---------|------------|--|--------------|---------|--------------------------|-------------------------------|--|
| Ø100 | Cl. 2,5 | MANOMETRE | 0/0,6..1..1,6..2,5..4..6..10..16..25..40..60..100..160..250..315..400..600 bar | bar/psi | 100 100 | <input type="checkbox"/> | Gövde: AISI 304 SS | |
| | G 1/2" | VAKUMMETRE | -760/0 mmHg -1/0 bar Manovakummetre: -1/+0,6..1,5..3..5..9..15..24 bar | mmHg bar/psi | 100 200 | <input type="checkbox"/> | Kapak: AISI 304 SS | |
| | IP65 | | | | | | Basınç Elemanı: Bakır Alaşımı | |
| | | | | | | | Bağlantı Elemanı: Piriç | |
| | | | | | | | Mekanizma : Piriç | |



-1...60 bar
€15,95

100...600 bar
€16,40

Bağlantı Tipi No : - - - - - 11
Alttan Bağlantılı



-1...60 bar
€19,85

100...600 bar
€20,30

Bağlantı Tipi No : - - - - - 12
Arkadan Bağlantılı



-1...60 bar
€23,25

100...600 bar
€23,90

Bağlantı Tipi No : - - - - - 13
Arkadan Bağlantılı Pano Tip

CE 200 bar üzerindeki basınçlar için geçerlidir.

GLİSERİN DOLGULU

| | | | | | | | |
|-------------|---------|----------------|---|---------|---|---|---|
| Ø160 | Cl. 1,6 | MANOMETRE | 0/2,5..4..6..10..16..25..40..60..100..160..250..315..400..600 bar | bar/psi | 160 100 <input type="checkbox"/> | Gövde: AISI 304 SS |    |
| | G 1/2" | MANOVAKUMMETRE | -1/+1,5..3..5..9..15..24 bar | bar/psi | 160 200 <input type="checkbox"/> | Kapak: AISI 304 SS | |
| | IP65 | | | | | Başıncı Elemanı: Bakır Alaşımı Bağlantı Elemanı: Pirinç Mekanizma : Piriç | |





-1...600 bar
€34,95

Bağlantı Tipi No : - - - - - **11**

Alttan Bağlantılı



KOMPLE PASLANMAZ

| | | | | | | | |
|------------|---------|----------------|---|---------|---|--|---|
| Ø63 | Cl. 2,5 | MANOMETRE | 0/2,5..4..6..10..16..25..40..60..100..160..250..315..400..600 bar | bar/psi | 063 101 <input type="checkbox"/> | Gövde: AISI 316L SS |    |
| | G 1/4" | MANOVAKUMMETRE | -1/+1,5..3..5..9..15..24 bar | bar/psi | 063 201 <input type="checkbox"/> | Kapak: AISI 316L SS | |
| | IP65 | | | | | Başıncı Elemanı: AISI 316L SS Bağlantı Elemanı: AISI 316L SS Mekanizma : Paslanmaz | |

 Fiyat Sorunuz



-1...600 bar
€21,35

Bağlantı Tipi No : - - - - - **21**

Alttan Bağlantılı



 Fiyat Sorunuz



-1...600 bar
€24,45

Bağlantı Tipi No : - - - - - **24**

Arkadan Bağlantılı Eksenden Kaçık



 Fiyat Sorunuz



-1...600 bar
€27,05

Bağlantı Tipi No : - - - - - **25**

Arkadan Bağ. Eksenden Kaçık Pano Tip



GLİSERİN DOLGULU, KOMPLE PASLANMAZ

| | | | | | | | |
|------------|---------|----------------|---|---------|---|--|---|
| Ø63 | Cl. 2,5 | MANOMETRE | 0/2,5..4..6..10..16..25..40..60..100..160..250..315..400..600 bar | bar/psi | 063 101 <input type="checkbox"/> | Gövde: AISI 316L SS |    |
| | G 1/4" | MANOVAKUMMETRE | -1/+1,5..3..5..9..15..24 bar | bar/psi | 063 201 <input type="checkbox"/> | Kapak: AISI 316L SS | |
| | IP65 | | | | | Başıncı Elemanı: AISI 316L SS Bağlantı Elemanı: AISI 316L SS Mekanizma : Paslanmaz | |

 Fiyat Sorunuz



-1...600 bar
€21,70

Bağlantı Tipi No : - - - - - **11**

Alttan Bağlantılı



 Fiyat Sorunuz



-1...600 bar
€24,75

Bağlantı Tipi No : - - - - - **14**

Arkadan Bağlantılı Eksenden Kaçık



 Fiyat Sorunuz



-1...600 bar
€27,35

Bağlantı Tipi No : - - - - - **15**

Arkadan Bağ. Eksenden Kaçık Pano Tip



STANDART

| | | | | | | | | |
|------|---------|------------|--|--------------|---------|--------------------------|------------------------------------|--|
| Ø100 | Cl. 1.0 | MANOMETRE | 0/0,6..1..1,6..2,5..4..6..10..16..25..40..60..100..160..250..315..400..600 bar | bar/psi | 100 110 | <input type="checkbox"/> | Gövde: Metal (Siyah Boyalı) | |
| | G 1/2" | VAKUMMETRE | -760/0 mmHg -1/0 bar Manovakummetre: -1/+0,6..1,5..3..5..9..15..24 bar | mmHg bar/psi | 100 210 | <input type="checkbox"/> | Kapak: Metal (Bayonet, Siyah Boy.) | |
| | IP41 | | | | | | Basınç Elemanı: Bakır Alaşımı | |
| | | | | | | | Bağlantı Elemanı: Piring | |
| | | | | | | | Mekanizma : Piring | |

| | | | | | |
|--|--|--|--|---|--|
| | 0,6..1,6 bar €33,25 2,5..600 bar €30,20 | | 0,6..1,6 bar €36,50 2,5..600 bar €33,85 | | 0,6..1,6 bar €38,20 2,5..600 bar €34,90 |
| Bağlantı Tipi No : - - - - - 01 Alttan Bağlantılı | | Bağlantı Tipi No : - - - - - 04 Arkadan Bağlantılı Eksenden Kaçık | | Bağlantı Tipi No : - - - - - 05 Arkadan Bağlantılı Eksenden Kaçık Pano Tip | |





| | | | | | | | | |
|------|---------|------------|--|--------------|---------|--------------------------|------------------------------------|--|
| Ø160 | Cl. 1.0 | MANOMETRE | 0/0,6..1..1,6..2,5..4..6..10..16..25..40..60..100..160..250..315..400..600 bar | bar/psi | 160 110 | <input type="checkbox"/> | Gövde: Metal (Siyah Boyalı) | |
| | G 1/2" | VAKUMMETRE | -760/0 mmHg -1/0 bar Manovakummetre: -1/+0,6..1,5..3..5..9..15..24 bar | mmHg bar/psi | 160 210 | <input type="checkbox"/> | Kapak: Metal (Bayonet, Siyah Boy.) | |
| | IP41 | | | | | | Basınç Elemanı: Bakır Alaşımı | |
| | | | | | | | Bağlantı Elemanı: Piring | |
| | | | | | | | Mekanizma : Piring | |

| | | | | | |
|--|--|--|--|---|--|
| | 0,6..1,6 bar €42,45 2,5..600 bar €38,25 | | 0,6..1,6 bar €43,80 2,5..600 bar €39,90 | | 0,6..1,6 bar €49,25 2,5..600 bar €44,75 |
| Bağlantı Tipi No : - - - - - 01 Alttan Bağlantılı | | Bağlantı Tipi No : - - - - - 04 Arkadan Bağlantılı Eksenden Kaçık | | Bağlantı Tipi No : - - - - - 05 Arkadan Bağlantılı Eksenden Kaçık Pano Tip | |





| | | | | | | | | |
|------|---------|------------|--|--------------|---------|--------------------------|-------------------------------|--|
| Ø250 | Cl. 1.0 | MANOMETRE | 0/0,6..1..1,6..2,5..4..6..10..16..25..40..60..100..160..250..315..400..600 bar | bar/psi | 250 110 | <input type="checkbox"/> | Gövde: Metal (Siyah Boyalı) | |
| | G 1/2" | VAKUMMETRE | -760/0 mmHg -1/0 bar Manovakummetre: -1/+0,6..1,5..3..5..9..15..24 bar | mmHg bar/psi | 250 210 | <input type="checkbox"/> | Kapak: Metal (Siyah Boyalı) | |
| | IP41 | | | | | | Basınç Elemanı: Bakır Alaşımı | |
| | | | | | | | Bağlantı Elemanı: Piring | |
| | | | | | | | Mekanizma : Piring | |

| | | | |
|--|--|---|--|
| | 0,6..1,6 bar €75,70 2,5..600 bar €71,70 | | 0,6..1,6 bar €99,00 2,5..600 bar €95,60 |
| Bağlantı Tipi No : - - - - - 01 Alttan Bağlantılı | | Bağlantı Tipi No : - - - - - 02 Arkadan Bağlantılı | |

SIVI DOLGULU

| | | | | | | | | |
|------|---------|-------------|--|--------------|---------|--------------------------|---|--|
| Ø100 | Cl. 1,0 | MANOMETRE | 0/0,6..1..1,6..2,5..4..6..10..16..25..40..60..100..160..250..315..400..600 bar | bar/psi | 100 110 | <input type="checkbox"/> | Gövde: AISI 304 SS Kapak: AISI 304 SS (Bayonet) Basınç Elemanı: Bakır Alaşımı Bağlantı Elemanı: Pirinç Mekanizma : Pirinç |     |
| | G 1/2" | VAKUMMETRE* | -760/0 mmHg -1/0 bar *Manovakummetre: -1/+0,6..1,5..3..5..9..15..24 bar | mmHg bar/psi | 100 210 | <input type="checkbox"/> | | |
| | IP65 | | | | | | | |

| | | | | | |
|---|---|---|--|---|---|
|  | 0,6..1,6 bar €36,80 2,5..600 bar €34,40 |  | 0,6..1,6 bar €38,80 2,5..600 bar €37,10 |  | 0,6..1,6 bar €44,80 2,5..600 bar €42,80 |
| Bağlantı Tipi No : - - - - - 11 Alttan Bağlantılı |  | Bağlantı Tipi No : - - - - - 14 Arkadan Bağlantılı Eksenden Kaçık |  | Bağlantı Tipi No : - - - - - 15 Arkadan Bağlantılı Eksenden Kaçık Pano Tip |  |

| | | | | | | | | |
|------|---------|-------------|--|--------------|---------|--------------------------|---|--|
| Ø160 | Cl. 1,0 | MANOMETRE | 0/0,6..1..1,6..2,5..4..6..10..16..25..40..60..100..160..250..315..400..600 bar | bar/psi | 160 110 | <input type="checkbox"/> | Gövde: AISI 304 SS Kapak: AISI 304 SS (Bayonet) Basınç Elemanı: Bakır Alaşımı Bağlantı Elemanı: Pirinç Mekanizma : Pirinç |     |
| | G 1/2" | VAKUMMETRE* | -760/0 mmHg -1/0 bar *Manovakummetre: -1/+0,6..1,5..3..5..9..15..24 bar | mmHg bar/psi | 160 210 | <input type="checkbox"/> | | |
| | IP65 | | | | | | | |

| | | | | | |
|--|---|--|--|--|---|
|  | 0,6..1,6 bar €55,20 2,5..600 bar €52,20 |  | 0,6..1,6 bar €56,90 2,5..600 bar €54,80 |  | 0,6..1,6 bar €69,60 2,5..600 bar €66,50 |
| Bağlantı Tipi No : - - - - - 11 Alttan Bağlantılı |  | Bağlantı Tipi No : - - - - - 14 Arkadan Bağlantılı Eksenden Kaçık |  | Bağlantı Tipi No : - - - - - 15 Arkadan Bağlantılı Eksenden Kaçık Pano Tip |  |

KOMPLE PASLANMAZ

| | | | | | | | | |
|------|---------|------------|--|--------------|---------|--------------------------|---|--------------|
| Ø100 | Cl. 1,0 | MANOMETRE | 0/0,6..1..1,6..2,5..4..6..10..16..25..40..60..100..160..250..315..400..600..1000 bar | bar/psi | 100 111 | <input type="checkbox"/> | Gövde: AISI 316L SS Kapak: AISI 316L SS (Bayonet) Basınç Elemanı: AISI 316L SS Bağlantı Elemanı: AISI 316L SS Mekanizma : Paslanmaz | |
| | G 1/2" | VAKUMMETRE | -760/0 mmHg -1/0 bar Manovakummetre: -1/+0,6..1,5..3..5..9..15..24 bar | mmHg bar/psi | 100 211 | <input type="checkbox"/> | | |
| | IP65 | | | | | | | |

Ex Fiyat Sorunuz

71 Doldurulamaz*

0,6..1,6 bar
€46,40

2,5..600 bar
€42,40

1000 bar
€47,80

Bağlantı Tipi No : - - - - - **21**

Alttan Bağlantılı

1

Ex Fiyat Sorunuz Request

74 Doldurulamaz*

0,6..1,6 bar
€48,70

2,5..600 bar
€47,70

1000 bar
€49,80

Bağlantı Tipi No : - - - - - **24**

Arkadan Bağlantılı Eksenden Kaçık

1

Ex Fiyat Sorunuz Request

75 Doldurulamaz*

0,6..1,6 bar
€52,60

2,5..600 bar
€53,30

1000 bar
€55,50

Bağlantı Tipi No : - - - - - **25**

Arkadan Bağlantılı Eksenden Kaçık Pano Tip

1

| | | | | | | | | |
|------|---------|-------------|--|--------------|---------|--------------------------|---|--------------|
| Ø160 | Cl. 1,0 | MANOMETRE | 0/0,6..1..1,6..2,5..4..6..10..16..25..40..60..100..160..250..315..400..600..1000 bar | bar/psi | 160 111 | <input type="checkbox"/> | Gövde: AISI 316L SS Kapak: AISI 316L SS (Bayonet) Basınç Elemanı: AISI 316L SS Bağlantı Elemanı: AISI 316L SS Mekanizma : Paslanmaz | |
| | G 1/2" | VAKUMMETRE* | -760/0 mmHg -1/0 bar *Manovakummetre: -1/+0,6..1,5..3..5..9..15..24 bar | mmHg bar/psi | 160 211 | <input type="checkbox"/> | | |
| | IP65 | | | | | | | |

Ex Fiyat Sorunuz

71 Doldurulamaz*

0,6..1,6 bar
€60,00

2,5..600 bar
€58,40

1000 bar
€65,60

Bağlantı Tipi No : - - - - - **21**

Alttan Bağlantılı

1

Ex Fiyat Sorunuz

74 Doldurulamaz*

0,6..1,6 bar
€67,00

2,5..600 bar
€63,00

1000 bar
€70,00

Bağlantı Tipi No : - - - - - **24**

Arkadan Bağlantılı Eksenden Kaçık

1

Ex Fiyat Sorunuz

75 Doldurulamaz*

0,6..1,6 bar
€68,00

2,5..600 bar
€65,00

1000 bar
€71,00

Bağlantı Tipi No : - - - - - **25**

Arkadan Bağlantılı Eksenden Kaçık Pano Tip

1

| | | | | | | | | |
|------|---------|-------------|--|--------------|---------|--------------------------|---|--------------|
| Ø250 | Cl. 1,0 | MANOMETRE | 0/0,6..1..1,6..2,5..4..6..10..16..25..40..60..100..160..250..315..400..600..1000 bar | bar/psi | 250 111 | <input type="checkbox"/> | Gövde: AISI 304 SS Kapak: AISI 304 SS Basınç Elemanı: AISI 316L SS Bağlantı Elemanı: AISI 316L SS Mekanizma : Paslanmaz | |
| | G 1/2" | VAKUMMETRE* | -760/0 mmHg -1/0 bar *Manovakummetre: -1/+0,6..1,5..3..5..9..15..24 bar | mmHg bar/psi | 250 211 | <input type="checkbox"/> | | |
| | IP41 | | | | | | | |

Ex Fiyat Sorunuz

01

Bağlantı Tipi No : - - - - - **01**

Alttan Bağlantılı

1

CE 200 bar üzerindeki basınçlar için geçerlidir.

* Ø100 ve Ø160 mm, 0,6..1,6 bar komple paslanmaz ürünlere dolum yapıldığında hatalı okumaya sebep olabilir. Dolum yapılmamalıdır.

KOMPLE PASLANMAZ, SIVI DOLGULU





| | | | | | | | | |
|------|---------|------------|--|--------------|---------|--------------------------|--|----------|
| Ø100 | Cl. 1,0 | MANOMETRE | 0/0,6..1..1,6..2,5..4..6..10..16..25..40..60..100..160..250..315..400..600..1000 bar | bar/psi | 100 111 | <input type="checkbox"/> | Gövde: AISI 316L SS | |
| | G 1/2" | VAKUMMETRE | -760/0 mmHg -1/0 bar Manovakummetre: -1/+0,6..1,5..3..5..9..15..24 bar | mmHg bar/psi | 100 211 | <input type="checkbox"/> | Kapak: AISI 316L SS (Bayonet) Basınç Elemanı: AISI 316L SS Bağlantı Elemanı: AISI 316L SS Mekanizma : Paslanmaz | |
| | IP65 | | | | | | | |

| | | | | | | | | |
|---------------------------------|--|-------------------------------|-----------------------------------|--|-------------------------------|--|--|-------------------------------|
| Ex Fiyat Sorunuz | | 0,6..1,6 bar €46,80 | Ex Fiyat Sorunuz | | 0,6..1,6 bar €50,30 | Ex Fiyat Sorunuz | | 0,6..1,6 bar €54,40 |
| | | 2,5..600 bar €43,80 | | | 2,5..600 bar €49,30 | | | 2,5..600 bar €55,10 |
| | | 1000 bar €49,30 | | | 1000 bar €54,80 | | | 1000 bar €60,40 |
| Bağlantı Tipi No : - - - - - 11 | | | Bağlantı Tipi No : - - - - - 14 | | | Bağlantı Tipi No : - - - - - 15 | | |
| Alttan Bağlantılı | | | Arkadan Bağlantılı Eksenden Kaçık | | | Arkadan Bağlantılı Eksenden Kaçık Pano Tip | | |

| | | | | | | | | |
|------|---------|------------|--|--------------|---------|--------------------------|--|----------|
| Ø160 | Cl. 1,0 | MANOMETRE | 0/0,6..1..1,6..2,5..4..6..10..16..25..40..60..100..160..250..315..400..600..1000 bar | bar/psi | 160 111 | <input type="checkbox"/> | Gövde: AISI 316L SS | |
| | G 1/2" | VAKUMMETRE | -760/0 mmHg -1/0 bar Manovakummetre: -1/+0,6..1,5..3..5..9..15..24 bar | mmHg bar/psi | 160 211 | <input type="checkbox"/> | Kapak: AISI 316L SS (Bayonet) Basınç Elemanı: AISI 316L SS Bağlantı Elemanı: AISI 316L SS Mekanizma : Paslanmaz | |
| | IP65 | | | | | | | |

| | | | | | | | | |
|---------------------------------|--|-------------------------------|-----------------------------------|--|-------------------------------|--|--|-------------------------------|
| Ex Fiyat Sorunuz | | 0,6..1,6 bar €64,00 | Ex Fiyat Sorunuz | | 0,6..1,6 bar €71,00 | Ex Fiyat Sorunuz | | 0,6..1,6 bar €73,00 |
| | | 2,5..600 bar €62,40 | | | 2,5..600 bar €68,10 | | | 2,5..600 bar €70,10 |
| | | 1000 bar €69,60 | | | 1000 bar €73,80 | | | 1000 bar €70,80 |
| Bağlantı Tipi No : - - - - - 11 | | | Bağlantı Tipi No : - - - - - 14 | | | Bağlantı Tipi No : - - - - - 15 | | |
| Alttan Bağlantılı | | | Arkadan Bağlantılı Eksenden Kaçık | | | Arkadan Bağlantılı Eksenden Kaçık Pano Tip | | |

SOLID FRONT

| | | | | | | | | |
|------|---------|------------|--|--------------|---------|--------------------------|--|---|
| Ø100 | Cl. 1,0 | MANOMETRE | 0/0,6..1..1,6..2,5..4..6..10..16..25..40..60..100..160..250..315..400..600..1000 bar | bar/psi | 100 111 | <input type="checkbox"/> | Gövde: AISI 316L SS |     |
| | G 1/2" | VAKUMMETRE | -760/0 mmHg -1/0 bar Manovakummetre: -1/+0,6..1,5..3..5..9..15..24 bar | mmHg bar/psi | 100 211 | <input type="checkbox"/> | Kapak: AISI 316L SS (Bayonet) Basınç Elemanı: AISI 316L SS Bağlantı Elemanı: AISI 316L SS Mekanizma : Paslanmaz | |
| | IP65 | | | | | | | |







İsteğe bağlı sıvı dolgulu üretilmektedir.

Bağlantı Tipi No : - - - - - 51 61 Sıvı Dolgulu

Alttan Bağlantılı



| | | | | | | | | |
|------|---------|------------|--|--------------|---------|--------------------------|--|---|
| Ø160 | Cl. 1,0 | MANOMETRE | 0/0,6..1..1,6..2,5..4..6..10..16..25..40..60..100..160..250..315..400..600..1000 bar | bar/psi | 160 111 | <input type="checkbox"/> | Gövde: AISI 316L SS |     |
| | G 1/2" | VAKUMMETRE | -760/0 mmHg -1/0 bar Manovakummetre: -1/+0,6..1,5..3..5..9..15..24 bar | mmHg bar/psi | 160 211 | <input type="checkbox"/> | Kapak: AISI 316L SS (Bayonet) Basınç Elemanı: AISI 316L SS Bağlantı Elemanı: AISI 316L SS Mekanizma : Paslanmaz | |
| | IP65 | | | | | | | |





İsteğe bağlı sıvı dolgulu üretilmektedir.

Bağlantı Tipi No : - - - - - 51 61 Sıvı Dolgulu

Alttan Bağlantılı



NO - NC - NCNO - NONC - NONO-NCNC **STANDART**

| | | | | | | | |
|-------------|--------|------------------|--|---|---|---|---|
| Ø100 | CL 1,0 | MANOMETRE | 0/0,6..1..1,6..2,5..4..6..10..16..25..40..60..100..160..250..315..400..600 bar | bar | 100 110 <input type="checkbox"/> | Gövde: AISI 304 SS Kapak: AISI 304 SS (Bayonet) Basınç Elemanı: Bakır Alaşımı Bağlantı Elemanı: Piring Mekanizma : Piring |    |
| | G 1/2" | | VAKUMMETRE | -760/0 mmHg -1/0 bar *Manovakummetre: -1/+0,6..1,5..3..5..9..15..24 bar | mmHg bar | | |
| | IP65 | | | | | | |



TEK KONTAKLI
€100,00
ÇİFT KONTAKLI
€120,00

24V-250V
Max. 0,6A
Max. 30W=50VA

Bağlantı Tipi No : - - - - - **71** Doldurulamaz

Alttan Bağlantılı



TEK KONTAKLI
€103,00
ÇİFT KONTAKLI
€123,00

24V-250V
Max. 0,6A
Max. 30W=50VA

Bağlantı Tipi No : - - - - - **74** Doldurulamaz

Arkadan Bağlantılı Eksenden Kaçık





TEK KONTAKLI
€109,00
ÇİFT KONTAKLI
€129,00

24V-250V
Max. 0,6A
Max. 30W=50VA

Bağlantı Tipi No : - - - - - **75** Doldurulamaz

Arkadan Bağlantılı Eksenden Kaçık Pano Tip

| | | | | | | | |
|-------------|--------|------------------|--|--|---|---|---|
| Ø160 | CL 1,0 | MANOMETRE | 0/0,6..1..1,6..2,5..4..6..10..16..25..40..60..100..160..250..315..400..600 bar | bar | 160 110 <input type="checkbox"/> | Gövde: AISI 304 SS Kapak: AISI 304 SS (Bayonet) Basınç Elemanı: Bakır Alaşımı Bağlantı Elemanı: Piring Mekanizma : Piring |    |
| | G 1/2" | | VAKUMMETRE | -760/0 mmHg -1/0 bar Manovakummetre: -1/+0,6..1,5..3..5..9..15..24 bar | mmHg bar | | |
| | IP65 | | | | | | |



TEK KONTAKLI
€120,00
ÇİFT KONTAKLI
€140,00

24V-250V
Max. 0,6A
Max. 30W=50VA

Bağlantı Tipi No : - - - - - **71** Doldurulamaz

Alttan Bağlantılı



TEK KONTAKLI
€123,00
ÇİFT KONTAKLI
€143,00

24V-250V
Max. 0,6A
Max. 30W=50VA

Bağlantı Tipi No : - - - - - **74** Doldurulamaz

Arkadan Bağlantılı Eksenden Kaçık





TEK KONTAKLI
€134,00
ÇİFT KONTAKLI
€154,00

24V-250V
Max. 0,6A
Max. 30W=50VA

Bağlantı Tipi No : - - - - - **75** Doldurulamaz

Arkadan Bağlantılı Eksenden Kaçık Pano Tip

NO - NC - NCNO - NONC - NONO-NCNC **STANDART SİLİKON DOLGULU**

| | | | | | | | |
|-------------|--------|------------------|--|--|---|---|---|
| Ø100 | CL 1,0 | MANOMETRE | 0/0,6..1..1,6..2,5..4..6..10..16..25..40..60..100..160..250..315..400..600 bar | bar | 100 110 <input type="checkbox"/> | Gövde: AISI 304 SS Kapak: AISI 304 SS (Bayonet) Basınç Elemanı: Bakır Alaşımı Bağlantı Elemanı: Piring Mekanizma : Piring |    |
| | G 1/2" | | VAKUMMETRE | -760/0 mmHg -1/0 bar Manovakummetre: -1/+0,6..1,5..3..5..9..15..24 bar | mmHg bar | | |
| | IP65 | | | | | | |



TEK KONTAKLI
€133,00
ÇİFT KONTAKLI
€153,00

24V-250V
Max. 0,6A
Max. 30W=50VA

Bağlantı Tipi No : - - - - - **11**

Alttan Bağlantılı



TEK KONTAKLI
€138,00
ÇİFT KONTAKLI
€158,00

24V-250V
Max. 0,6A
Max. 30W=50VA

Bağlantı Tipi No : - - - - - **14**

Arkadan Bağlantılı Eksenden Kaçık





TEK KONTAKLI
€144,00
ÇİFT KONTAKLI
€164,00

24V-250V
Max. 0,6A
Max. 30W=50VA

Bağlantı Tipi No : - - - - - **15**

Arkadan Bağlantılı Eksenden Kaçık Pano Tip

| | | | | | | | |
|-------------|--------|------------------|--|--|---|---|---|
| Ø160 | CL 1,0 | MANOMETRE | 0/0,6..1..1,6..2,5..4..6..10..16..25..40..60..100..160..250..315..400..600 bar | bar | 160 110 <input type="checkbox"/> | Gövde: AISI 304 SS Kapak: AISI 304 SS (Bayonet) Basınç Elemanı: Bakır Alaşımı Bağlantı Elemanı: Piring Mekanizma : Piring |    |
| | G 1/2" | | VAKUMMETRE | -760/0 mmHg -1/0 bar Manovakummetre: -1/+0,6..1,5..3..5..9..15..24 bar | mmHg bar | | |
| | IP65 | | | | | | |



TEK KONTAKLI
€177,00
ÇİFT KONTAKLI
€197,00

24V-250V
Max. 0,6A
Max. 30W=50VA

Bağlantı Tipi No : - - - - - **11**

Alttan Bağlantılı



TEK KONTAKLI
€183,00
ÇİFT KONTAKLI
€203,00

24V-250V
Max. 0,6A
Max. 30W=50VA

Bağlantı Tipi No : - - - - - **14**

Arkadan Bağlantılı Eksenden Kaçık



TEK KONTAKLI
€185,00
ÇİFT KONTAKLI
€205,00



24V-250V
Max. 0,6A
Max. 30W=50VA

Bağlantı Tipi No : - - - - - **15**

Arkadan Bağlantılı Eksenden Kaçık Pano Tip

CE 200 bar üzerindeki basınçlar için geçerlidir.

KOMPLE PASLANMAZ NO - NC - NCNO - NONC - NONO-NCNC

| | | | | | | | | |
|-------------|---------|------------|--|----------|---------|--------------------------|---|---|
| Ø100 | Cl. 1,0 | MANOMETRE | 0/0,6..1..1,6..2,5..4..6..10..16..25..40..60..100..160..250..315..400..600..1000 bar | bar | 100 111 | <input type="checkbox"/> | Gövde: AISI 316L SS Kapak: AISI 316L SS (Bayonet) Basınç Elemanı: AISI 316L SS Bağlantı Elemanı: AISI 316L SS Mekanizma : Paslanmaz |    |
| | G 1/2" | VAKUMMETRE | -760/0 mmHg -1/0 bar Manovakummetre: -1/+0,6..1,5..3..5..9..15..24 bar | mmHg bar | 100 211 | <input type="checkbox"/> | | |
| | IP65 | | | | | | | |

Ex Fiyat Sorunuz



TEK KONTAKLI
€115,00

ÇİFT KONTAKLI
€135,00

Bağlantı Tipi No : - - - - - **71** Doldurulamaz

Alttan Bağlantılı

1

Ex Fiyat Sorunuz



TEK KONTAKLI
€120,00

ÇİFT KONTAKLI
€140,00

Bağlantı Tipi No : - - - - - **74** Doldurulamaz

Arkadan Bağlantılı Eksenden Kaçık

1

Ex Fiyat Sorunuz





TEK KONTAKLI
€125,00

ÇİFT KONTAKLI
€145,00

Bağlantı Tipi No : - - - - - **75** Doldurulamaz

Arkadan Bağlantılı Eksenden Kaçık Pano Tip

1

| | | | | | | | | |
|-------------|---------|------------|--|----------|---------|--------------------------|---|---|
| Ø160 | Cl. 1,0 | MANOMETRE | 0/0,6..1..1,6..2,5..4..6..10..16..25..40..60..100..160..250..315..400..600..1000 bar | bar | 160 111 | <input type="checkbox"/> | Gövde: AISI 316L SS Kapak: AISI 316L SS (Bayonet) Basınç Elemanı: AISI 316L SS Bağlantı Elemanı: AISI 316L SS Mekanizma : Paslanmaz |    |
| | G 1/2" | VAKUMMETRE | -760/0 mmHg -1/0 bar Manovakummetre: -1/+0,6..1,5..3..5..9..15..24 bar | mmHg bar | 160 211 | <input type="checkbox"/> | | |
| | IP65 | | | | | | | |

Ex Fiyat Sorunuz



TEK KONTAKLI
€129,00

ÇİFT KONTAKLI
€149,00

Bağlantı Tipi No : - - - - - **71** Doldurulamaz

Alttan Bağlantılı

1

Ex Fiyat Sorunuz



TEK KONTAKLI
€135,00

ÇİFT KONTAKLI
€155,00

Bağlantı Tipi No : - - - - - **74** Doldurulamaz

Arkadan Bağlantılı Eksenden Kaçık

1

Ex Fiyat Sorunuz



TEK KONTAKLI
€137,00



ÇİFT KONTAKLI
€157,00

Bağlantı Tipi No : - - - - - **75** Doldurulamaz

Arkadan Bağlantılı Eksenden Kaçık Pano Tip

1

KOMPLE PASLANMAZ, SİLİKON DOLGULU NO - NC - NCNO - NONC - NONO-NCNC

| | | | | | | | | |
|-------------|---------|------------|--|----------|---------|--------------------------|---|---|
| Ø100 | Cl. 1,0 | MANOMETRE | 0/0,6..1..1,6..2,5..4..6..10..16..25..40..60..100..160..250..315..400..600..1000 bar | bar | 100 111 | <input type="checkbox"/> | Gövde: AISI 316L SS Kapak: AISI 316L SS (Bayonet) Basınç Elemanı: AISI 316L SS Bağlantı Elemanı: AISI 316L SS Mekanizma : Paslanmaz |    |
| | G 1/2" | VAKUMMETRE | -760/0 mmHg -1/0 bar Manovakummetre: -1/+0,6..1,5..3..5..9..15..24 bar | mmHg bar | 100 211 | <input type="checkbox"/> | | |
| | IP65 | | | | | | | |

Ex Fiyat Sorunuz



TEK KONTAKLI
€139,00

ÇİFT KONTAKLI
€159,00

Bağlantı Tipi No : - - - - - **11**

Alttan Bağlantılı

1

Ex Fiyat Sorunuz



TEK KONTAKLI
€143,00

ÇİFT KONTAKLI
€163,00

Bağlantı Tipi No : - - - - - **14**

Arkadan Bağlantılı Eksenden Kaçık

1

Ex Fiyat Sorunuz





TEK KONTAKLI
€157,00

ÇİFT KONTAKLI
€177,00

Bağlantı Tipi No : - - - - - **15**

Arkadan Bağlantılı Eksenden Kaçık Pano Tip

1

| | | | | | | | | |
|-------------|---------|------------|--|----------|---------|--------------------------|---|---|
| Ø160 | Cl. 1,0 | MANOMETRE | 0/0,6..1..1,6..2,5..4..6..10..16..25..40..60..100..160..250..315..400..600..1000 bar | bar | 160 111 | <input type="checkbox"/> | Gövde: AISI 316L SS Kapak: AISI 316L SS (Bayonet) Basınç Elemanı: AISI 316L SS Bağlantı Elemanı: AISI 316L SS Mekanizma : Paslanmaz |    |
| | G 1/2" | VAKUMMETRE | -760/0 mmHg -1/0 bar Manovakummetre: -1/+0,6..1,5..3..5..9..15..24 bar | mmHg bar | 160 211 | <input type="checkbox"/> | | |
| | IP65 | | | | | | | |

Ex Fiyat Sorunuz



TEK KONTAKLI
€179,00

ÇİFT KONTAKLI
€199,00

Bağlantı Tipi No : - - - - - **11**

Alttan Bağlantılı

1

Ex Fiyat Sorunuz



TEK KONTAKLI
€186,00

ÇİFT KONTAKLI
€206,00

Bağlantı Tipi No : - - - - - **14**

Arkadan Bağlantılı Eksenden Kaçık

1

Ex Fiyat Sorunuz



TEK KONTAKLI
€192,00

ÇİFT KONTAKLI
€212,00

Bağlantı Tipi No : - - - - - **15**

Arkadan Bağlantılı Eksenden Kaçık Pano Tip

1

CE 200 bar üzerindeki basınçlar için geçerlidir.

MANO TRANSMİTERLER

| | | | | | |
|--------------|----------------|---|---------|--------------|---|
| Ø100 Ø160 | CL 1,0 | MANO TRANSMİTER (Ø100) -1/0..0/1..1,6..2,5..4..6..10..16..25..40..60 bar | bar/psi | MT100 111 71 | Gövde: AISI 316L SS Kapak: AISI 316L SS (Bayonet) Basınç Elemanı: AISI 316L SS Bağlantı Elemanı: AISI 316L SS Mekanizma : Paslanmaz |
| | G 1/2" IP65 | MANO TRANSMİTER (Ø160) -1/0..0/1..1,6..2,5..4..6..10..16..25..40..60..100..160..250..400..600 bar | bar/psi | MT160 111 71 | |



Ø100
Seramik Sensör
€148,00

4-20 mA - bar
Büyük Soket

Linearity : 0,5% (FS)
Accuracy : 1,0% (FS)



Ø160
Seramik Sensör
€172,00

4-20 mA - bar
Büyük Soket

Linearity : 0,5% (FS)
Accuracy : 1,0% (FS)

TRANSMİTERLER

| | | | | | |
|------------------|------|--------|--|---------------|---------------------|
| MPS-10 MPS-20 | IP65 | MPS-10 | -1/0..0/0,5..1..1,6..2,5..4..5..6..10..16..20..25..40..60..100..160..250..400..600 bar | 4-20 mA / bar | Gövde: AISI 316L SS |
| | | MPS-20 | 0/6..10..16..25..40..60..100..160..250..400..600 bar | 4-20 mA / bar | |



MPS-10
Seramik Sensör

EN 175301-803 C
M12x1 Soket
EN 175301-803 A

Linearity : 0,5% (FS)
Accuracy : 1,0% (FS)



MPS-20
Thin Film Sensor

Linearity : 0,5% (FS)
Accuracy : 1,2% (FS)

| Model No: | Soket | Bağlantı | Basınç Aralığı (bar) | € |
|---------------------|-----------------|----------|-----------------------|----------------|
| 71011100../MPS10 | EN 175301-803 C | G 1/4" | 1-4 | 78,50 |
| | | | 6-25 | 63,00 |
| | | | 40-600 | 86,00 |
| 71011101../MPS10 | EN 175301-803 C | G 1/2" | 1-4 | 80,50 |
| | | | 6-25 | 65,00 |
| | | | 40-600 | 88,00 |
| 71011100../EX/MPS10 | EN 175301-803 C | G 1/4" | 1-4 6-25 40-600 | Fiyat sorunuz. |
| 71011101../EX/MPS10 | EN 175301-803 C | G 1/2" | | |
| 71061100../MPS10 | M12x1 Soket | G 1/4" | | |
| 71061101../MPS10 | M12x1 Soket | G 1/2" | | |
| 71061100../EX/MPS10 | M12x1 Soket | G 1/4" | | |
| 71061101../EX/MPS10 | M12x1 Soket | G 1/2" | | |
| 71031100../MPS10 | EN 175301-803 A | G 1/4" | | |
| 71031101../MPS10 | EN 175301-803 A | G 1/2" | | |
| 71031100../EX/MPS10 | EN 175301-803 A | G 1/4" | | |
| 71031101../EX/MPS10 | EN 175301-803 A | G 1/2" | | |

| Model No: | Bağlantı | Soket | € |
|------------------|----------|------------------|----------------|
| 71011100../MPS20 | G 1/4" | DIN 175301-803 A | Fiyat sorunuz. |

STANDART

| | | | | | | | | |
|-----|--------|------------|---|------|---------|--------------------------|---|--|
| Ø63 | CL 1,6 | MANOMETRE | 0/25..40..60..100..160..250..400..600..1000 mbar | mbar | 063 130 | <input type="checkbox"/> | Gövde: Metal (Sarı Boyalı) |   |
| | G 1/4" | VAKUMMETRE | -25/0..-40..-60..-100..-160..-250..-400..-600..-1000 mbar | mbar | 063 230 | <input type="checkbox"/> | Kapak: Akrilik Basınç Elemanı: Bakır Alaşımı Bağlantı Elemanı: Piring Mekanizma : Piring | |
| | IP41 | | | | | | | |



€17,90

Vakummetre için fiyat sorunuz.

Bağlantı Tipi No : - - - - - 01
Alttan Bağlantılı

€21,10



Vakummetre için fiyat sorunuz.

Bağlantı Tipi No : - - - - - 02
Arkadan BağlantılıMetal Gövde (Çinko Kaplama)
Metal Kapak (AISI 430)

€22,50

Vakummetre için fiyat sorunuz.

Bağlantı Tipi No : - - - - - 03
Arkadan Bağlantılı Pano Tip

| | | | | | | | | |
|-----|--------|------------|--|------|---------|--------------------------|---|--|
| Ø70 | CL 1,6 | VAKUMMETRE | -16/0..-25..-40..-60..-100..-160..-250..-400..-600..-1000 mbar | mbar | 070 230 | <input type="checkbox"/> | Gövde: Metal (Sarı Boyalı) Kapak: Metal (Sarı Boyalı) Basınç Elemanı: Bakır Alaşımı Bağlantı Elemanı: Piring Mekanizma : Piring |   |
| | G 1/2" | | | | | | | |
| | IP41 | | | | | | | |



€25,20

Ürün Kodu : 070 230 01 13 10
Alttan Bağlantılı Önden Flanşlı

| | | | | | | | | |
|------|--------|------------|--|------|---------|--------------------------|---|--|
| Ø100 | CL 1,6 | MANOMETRE | 0/16..25..40..60..100..160..250..400..600..1000 mbar | mbar | 100 130 | <input type="checkbox"/> | Gövde: Metal (Sarı Boyalı) Kapak: Metal (Sarı Boyalı) Basınç Elemanı: Bakır Alaşımı Bağlantı Elemanı: Piring Mekanizma : Piring |   |
| | G 1/2" | VAKUMMETRE | -16/0..-25..-40..-60..-100..-160..-250..-400..-600..-1000 mbar | mbar | 100 230 | <input type="checkbox"/> | | |
| | IP41 | | | | | | | |



€37,40

Vakummetre için fiyat sorunuz.

Bağlantı Tipi No : - - - - - 01
Alttan Bağlantılı

€43,40

Vakummetre için fiyat sorunuz.

Bağlantı Tipi No : - - - - - 02
Arkadan Bağlantılı

€47,40

Vakummetre için fiyat sorunuz.

Bağlantı Tipi No : - - - - - 03
Arkadan Bağlantılı Pano Tip

| | | | | | | | | |
|------|--------|------------|--|------|---------|--------------------------|---|--|
| Ø160 | CL 1,6 | MANOMETRE | 0/2,5..4..6..10..16..25..40..60..100..160..250..400..600..1000 mbar | mbar | 160 130 | <input type="checkbox"/> | Gövde: Metal (Sarı Boyalı) Kapak: Metal (Sarı Boyalı) Basınç Elemanı: Bakır Alaşımı Bağlantı Elemanı: Piring Mekanizma : Piring |   |
| | G 1/2" | VAKUMMETRE | -2,5/0..-16..-25..-40..-60..-100..-160..-250..-400..-600..-1000 mbar | mbar | 160 230 | <input type="checkbox"/> | | |
| | IP41 | | | | | | | |

2,5..25 mbar
Fiyat sorunuz.40..1000 mbar
€53,80

Vakummetre için fiyat sorunuz.

Bağlantı Tipi No : - - - - - 01
Alttan Bağlantılı16..25 mbar
Fiyat sorunuz.40..1000 mbar
€58,60

Vakummetre için fiyat sorunuz.

Bağlantı Tipi No : - - - - - 02
Arkadan Bağlantılı16..25 mbar
Fiyat sorunuz.40..1000 mbar
€64,10

Vakummetre için fiyat sorunuz.

Bağlantı Tipi No : - - - - - 03
Arkadan Bağlantılı Pano Tip

SIVI DOLGULU

| | | | | | | | |
|------------|--------|-------------|--|------|---|---|---|
| Ø63 | CL 1,6 | MANOMETRE | 0/100..160..250..400..600..1000 mbar | mbar | 063 130 <input type="checkbox"/> | Gövde: AISI 304 SS |  |
| | G 1/4" | VAKUMMETRE* | -100/0..-160..-250..-400..-600..-1000 mbar | mbar | 063 230 <input type="checkbox"/> | Kapak: AISI 304 SS | |
| | IP65 | | | | | Basınç Elemanı: Bakır Alaşımı Bağlantı Elemanı: Piriñç Mekanizma : Piriñç | |

| | | |
|---|--|---|
|  <p>100..1000 mbar €24,00</p> <p>Vakummetre için fiyat sorunuz.</p> <p>Bağlantı Tipi No : - - - - - 11 Alttan Bağlantılı</p> |  <p>160..1000 mbar €25,40</p> <p>Vakummetre için fiyat sorunuz.</p> <p>Bağlantı Tipi No : - - - - - 12 Arkadan Bağlantılı</p> |  <p>160..1000 mbar €27,20</p> <p>Vakummetre için fiyat sorunuz.</p> <p>Bağlantı Tipi No : - - - - - 13 Arkadan Bağlantılı Pano Tip</p> |
|---|--|---|

| | | | | | | | |
|-------------|--------|------------|---|------|---|---|---|
| Ø100 | CL 1,6 | MANOMETRE | 0/60..100..160..250..400..600..1000 mbar | mbar | 100 130 <input type="checkbox"/> | Gövde: AISI 304 SS |  |
| | G 1/2" | VAKUMMETRE | -60/0..-100..-160..-250..-400..-600..-1000 mbar | mbar | 100 230 <input type="checkbox"/> | Kapak: AISI 304 SS (Bayonet) | |
| | IP65 | | | | | Basınç Elemanı: Bakır Alaşımı Bağlantı Elemanı: Piriñç Mekanizma : Piriñç | |

| | | |
|---|---|--|
|  <p>€45,60</p> <p>Vakummetre için fiyat sorunuz.</p> <p>Bağlantı Tipi No : - - - - - 11 Alttan Bağlantılı</p> |  <p>€51,70</p> <p>Vakummetre için fiyat sorunuz.</p> <p>Bağlantı Tipi No : - - - - - 12 Arkadan Bağlantılı</p> |  <p>€55,70</p> <p>Vakummetre için fiyat sorunuz.</p> <p>Bağlantı Tipi No : - - - - - 13 Arkadan Bağlantılı Pano Tip</p> |
|---|---|--|

| | | | | | | | |
|-------------|--------|------------|---|------|---|---|---|
| Ø160 | CL 1,6 | MANOMETRE | 0/60..100..160..250..400..600..1000 mbar | mbar | 160 130 <input type="checkbox"/> | Gövde: AISI 304 SS |  |
| | G 1/2" | VAKUMMETRE | -60/0..-100..-160..-250..-400..-600..-1000 mbar | mbar | 160 230 <input type="checkbox"/> | Kapak: AISI 304 SS (Bayonet) | |
| | IP65 | | | | | Basınç Elemanı: Bakır Alaşımı Bağlantı Elemanı: Piriñç Mekanizma : Piriñç | |

| | | |
|--|---|--|
|  <p>€62,50</p> <p>Vakummetre için fiyat sorunuz.</p> <p>Bağlantı Tipi No : - - - - - 11 Alttan Bağlantılı</p> |  <p>€67,30</p> <p>Vakummetre için fiyat sorunuz.</p> <p>Bağlantı Tipi No : - - - - - 12 Arkadan Bağlantılı</p> |  <p>€71,50</p> <p>Vakummetre için fiyat sorunuz.</p> <p>Bağlantı Tipi No : - - - - - 13 Arkadan Bağlantılı Pano Tip</p> |
|--|---|--|

KOMPLE PASLANMAZ

| | | | | | | | | |
|------|--------|------------|---|------|---------|--------------------------|---|--|
| Ø100 | CL 1,6 | MANOMETRE | 0/25..40..60..100..160..250..400..600..1000 mbar | mbar | 100 131 | <input type="checkbox"/> | Gövde: AISI 316L SS Kapak: AISI 316L SS (Bayonet) Basınç Elemanı: AISI 316L SS Bağlantı Elemanı: AISI 316L SS Mekanizma : Paslanmaz | |
| | G 1/2" | VAKUMMETRE | -25/0..-40..-60..-100..-160..-250..-400..-600..-1000 mbar | mbar | 100 231 | <input type="checkbox"/> | | |
| | IP41 | | | | | | | |



€109,00

Vakummetre için fiyat sorunuz.

Bağlantı Tipi No : - - - - - 01

Alttan Bağlantılı



€111,00

Vakummetre için fiyat sorunuz.

Bağlantı Tipi No : - - - - - 02

Arkadan Bağlantılı



€113,00

Vakummetre için fiyat sorunuz.

Bağlantı Tipi No : - - - - - 03

Arkadan Bağlantılı Pano Tip



| | | | | | | | | |
|------|--------|------------|--|------|---------|--------------------------|---|--|
| Ø160 | CL 1,6 | MANOMETRE | 0/6..10..16..25..40..60..100..160..250..400..600..1000 mbar | mbar | 160 131 | <input type="checkbox"/> | Gövde: AISI 316L SS Kapak: AISI 316L SS (Bayonet) Basınç Elemanı: AISI 316L SS Bağlantı Elemanı: AISI 316L SS Mekanizma : Paslanmaz | |
| | G 1/2" | VAKUMMETRE | -6/0..-10..-25..-40..-60..-100..-160..-250..-400..-600..-1000 mbar | mbar | 160 231 | <input type="checkbox"/> | | |
| | IP41 | | | | | | | |



6..25 mbar

Fiyat sorunuz.

40..1000 mbar

€141,00

Vakummetre için fiyat sorunuz.

Bağlantı Tipi No : - - - - - 01

Alttan Bağlantılı



25..1000 mbar

€145,00

Vakummetre için fiyat sorunuz.

Bağlantı Tipi No : - - - - - 02

Arkadan Bağlantılı



25..1000 mbar

€151,00

Vakummetre için fiyat sorunuz.

Bağlantı Tipi No : - - - - - 03

Arkadan Bağlantılı Pano Tip



KOMPLE PASLANMAZ, SIVI DOLGULU

| | | | | | | | | |
|------|--------|------------|---|------|---------|--------------------------|---|--|
| Ø100 | CL 1,6 | MANOMETRE | 0/60..100..160..250..400..600..1000 mbar | mbar | 100 131 | <input type="checkbox"/> | Gövde: AISI 316L SS Kapak: AISI 316L SS (Bayonet) Basınç Elemanı: AISI 316L SS Bağlantı Elemanı: AISI 316L SS Mekanizma : Paslanmaz | |
| | G 1/2" | VAKUMMETRE | -60/0..-100..-160..-250..-400..-600..-1000 mbar | mbar | 100 231 | <input type="checkbox"/> | | |
| | IP65 | | | | | | | |



€116,00

Vakummetre için fiyat sorunuz.



Fiyat Sorunuz

Bağlantı Tipi No : - - - - - 11

Alttan Bağlantılı



€118,00

Vakummetre için fiyat sorunuz.



Fiyat Sorunuz

Bağlantı Tipi No : - - - - - 12

Arkadan Bağlantılı



€120,00

Vakummetre için fiyat sorunuz.



Fiyat Sorunuz

Bağlantı Tipi No : - - - - - 13

Arkadan Bağlantılı Pano Tip



| | | | | | | | | |
|------|--------|-------------|---|------|---------|--------------------------|---|--|
| Ø160 | CL 1,6 | MANOMETRE | 0/60..100..160..250..400..600..1000 mbar | mbar | 160 131 | <input type="checkbox"/> | Gövde: AISI 316L SS Kapak: AISI 316L SS (Bayonet) Basınç Elemanı: AISI 316L SS Bağlantı Elemanı: AISI 316L SS Mekanizma : Paslanmaz | |
| | G 1/2" | VAKUMMETRE* | -60/0..-100..-160..-250..-400..-600..-1000 mbar | mbar | 160 231 | <input type="checkbox"/> | | |
| | IP65 | | | | | | | |



€149,00

Vakummetre için fiyat sorunuz.



Fiyat Sorunuz

Bağlantı Tipi No : - - - - - 11

Alttan Bağlantılı



€153,00

Vakummetre için fiyat sorunuz.



Fiyat Sorunuz

Bağlantı Tipi No : - - - - - 12

Arkadan Bağlantılı



€158,00

Vakummetre için fiyat sorunuz.



Fiyat Sorunuz

Bağlantı Tipi No : - - - - - 13

Arkadan Bağlantılı Pano Tip



STATİK BASINÇ TAM SKALA X 1,3

Ø100 **CL. 1.6** **G 1/2"** **IP65** **KAPSÜL DİYAFRAMLI FARK BASINÇ ÖLÇER** 0/25..40..60..100..160..250..400..600..1000 mbar **mbar** Gövde: AISI 304L SS
Kapak: AISI 316L SS
Basınç Elemanı: Paslanmaz
Bağlantı Elemanı: AISI 316L SS
Mekanizma: Paslanmaz

Fiyat sorunuz.



P+/G 1/2"
P-/G 1/2"
Model No: 100 161 71../0591
Alttan Bağlantı

Fiyat sorunuz.



P+/G 1/2"
P-/G 1/2"
Model No: 100 161 72../0591
Arkadan Bağlantı

Fiyat sorunuz.



P+/G 1/2"
P-/G 1/2"
Model No: 100 160 76../0591
Alttan Bağlantı, Arkadan Flaşlı

Gövde: AISI 304 SS
Kapak: AISI 304 SS
Basınç Elemanı: Bakır Alaşım
Bağlantı Elemanı: Pirinç
Mekanizma: Pirinç

Ø100 **CL. 1.0** **G 1/2"** **IP65** **BOURDON BORULU FARK BASINÇ ÖLÇER** Kuru Tip: 0,3/0/0,3...0,5/0/0,5 0,8/0/0,8 bar Doldurulabilir Tip: 1,25/0/1,25...2/0/2...3/0/3...5/0/5...8/0/8...12,5/0/12,5...20/0/20...30/0/30 bar **bar** Gövde: AISI 304L SS
Kapak: AISI 316L SS
Basınç Elemanı: AISI 316L SS
Bağlantı Elemanı: AISI 316L SS
Mekanizma: Paslanmaz

Fiyat sorunuz.

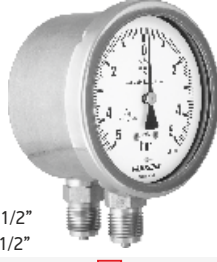

P+/G 1/2"
P-/G 1/2"
Model No: 100 161 []../0397
Alttan Bağlantı

Bağlantı Tipi No : - - - - - **71** IP65, Kuru Tip Doldurulamaz
Bağlantı Tipi No : - - - - - **21** Doldurulabilir Tip

Fiyat sorunuz.



P+/G 1/2"
P-/G 1/2"
Model No: 100 161 []../0397
Arkadan Bağlantı

Bağlantı Tipi No : - - - - - **72** IP65, Kuru Tip Doldurulamaz
Bağlantı Tipi No : - - - - - **22** Doldurulabilir Tip

STATİK BASINÇ MAKS. 100 BAR

80x80 **CL. 10** **G 1/4"** **IP65** **KAPSÜL DİYAFRAMLI FARK BASINÇ ÖLÇER** 0/+300, 0/+600, 0/+1000, 0/+2000 mbar **mbar/psi** Gövde: Pirinç
Kapak: Akritik

Ex Fiyat Sorunuz **Doğalgaz için**



P+/G 1/4"
P-/G 1/4"
* Standart kablo uzunluğu 2 metredir. İlave 1 mt kablo farkı 1,60 €'dir.

| Model No | Kollektör | Kontak | € |
|--------------|-----------|-----------|---------------|
| 080 162 | - | - | 54,00 |
| 080 162...NA | - | NO | 71,00 |
| 080 160 | Çelik | - | 96,00 |
| 080 160...NA | | NO | 113,00 |
| 080 161 | AISİ 316L | - | 144,00 |
| 080 161...NA | | NO | 161,00 |

STATİK BASINÇ MAKS. 250 BAR

Ø100
Ø160

Cl. 1,6
G 1/2"
IP65

FARK BASINÇ ÖLÇER

0/1..1,6..2,5..4..6..10..16..25 bar

bar

Gövde: AISI 316L SS
Kapak: AISI 316L SS
Basınç Elemanı: Paslanmaz
Bağlantı Elemanı: AISI 316L SS
Mekanizma: Paslanmaz



Fiyat Sorunuz

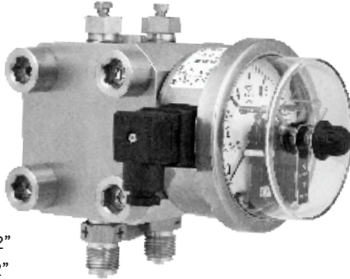

Ø100

Kontaksız,
Tek ve Çift Kontaklı
Modelleri mevcuttur.

Fiyat sorunuz.

P+/G 1/2"
P-/G 1/2"

Model No: 100 161 .../0597

Alttan Bağlantı



Bağlantı Tipi No : - - - - 11 Sıvı Dolgulu Tip
Bağlantı Tipi No : - - - - 21 Doldurulabilir Tip
Bağlantı Tipi No : - - - - 71 Kuru Tip Doldurulamaz



Fiyat Sorunuz



Ø160

Kontaksız,
Tek Kontaklı,
Çift Kontaklı
Modelleri mevcuttur.

Fiyat sorunuz.

P+/G 1/2"
P-/G 1/2"

Model No: 160 161 .../0597

Alttan Bağlantı



Bağlantı Tipi No : - - - - 11 Sıvı Dolgulu Tip
Bağlantı Tipi No : - - - - 21 Doldurulabilir Tip
Bağlantı Tipi No : - - - - 71 Kuru Tip Doldurulamaz

U-MANOMETRE

U

U-MANOMETRE

0/100, 0/120 mbar

mbar

0425

Gövde: Alüminyum



0...100 mbar

€46,10

0...120 mbar

€49,50











Diyafram ayırıcılı sistem siparişleriniz için aşağıdaki bilgileri müşteri temsilcimize iletiniz.

Çalışma Basıncı | Flanş Ölçüleri | Malzeme Detayı | Malzeme Kaplama Detayı* | Akışkan ve Çalışma Sıcaklığı
Diyafram ayırıcılı ürünler, basınç ölçer veya transmitter ile akuple olarak satılmaktadır.

Diğer diyafram modelleri için www.pakkens.com adresini ziyaret ediniz.



| | |
|---|--|
|   <p>0500 VİDA BAĞLANTILI</p> <p>Komple Paslanmaz AISI 316L SS</p> <p>Bağlantı Tipi No : ----- 01 Alttan Bağlantılı Bağlantı Tipi No : ----- 04 Arkadan Bağlantılı Eksenden Kaçık</p>  |   <p>0520 KADEMELİ FLANŞ BAĞLANTILI</p> <p>Komple Paslanmaz AISI 316L SS</p> <p>Bağlantı Tipi No : ----- 01 Alttan Bağlantılı Bağlantı Tipi No : ----- 04 Arkadan Bağlantılı Eksenden Kaçık</p>  |
|   <p>0522 DÜZ FLANŞ BAĞLANTILI</p> <p>Komple Paslanmaz AISI 316L SS</p> <p>Bağlantı Tipi No : ----- 01 Alttan Bağlantılı Bağlantı Tipi No : ----- 04 Arkadan Bağlantılı Eksenden Kaçık</p>  |   <p>0530 DÜZ FLANŞ ALTTAN BAĞLANTILI</p> <p>Komple Paslanmaz AISI 316L SS</p> <p>Bağlantı Tipi No : ----- 01 Alttan Bağlantılı Bağlantı Tipi No : ----- 04 Arkadan Bağlantılı Eksenden Kaçık</p>  |
|   <p>0550 00 GEÇME FLANŞ BAĞLANTILI</p> <p>Komple Paslanmaz AISI 316L SS</p> <p>Bağlantı Tipi No : ----- 01 Alttan Bağlantılı Bağlantı Tipi No : ----- 04 Arkadan Bağlantılı Eksenden Kaçık</p>  |   <p>0550 01 GEÇME FLANŞ BAĞLANTILI</p> <p>Komple Paslanmaz AISI 316L SS</p> <p>Bağlantı Tipi No : ----- 01 Alttan Bağlantılı Bağlantı Tipi No : ----- 04 Arkadan Bağlantılı Eksenden Kaçık</p>  |
|   <p>0550 03 GEÇME FLANŞ BAĞLANTILI</p> <p>Komple Paslanmaz AISI 316L SS</p> <p>Bağlantı Tipi No : ----- 01 Alttan Bağlantılı Bağlantı Tipi No : ----- 04 Arkadan Bağlantılı Eksenden Kaçık</p>  |   <p>0552 DİYAFRAM FLANŞ BAĞLANTILI</p> <p>Komple Paslanmaz AISI 316L SS</p> <p>Bağlantı Tipi No : ----- 01 Alttan Bağlantılı Bağlantı Tipi No : ----- 04 Arkadan Bağlantılı Eksenden Kaçık</p>  |

DİYAFRAM AYIRICILAR

Diyafram ayırıcılı sistem siparişleriniz için aşağıdaki bilgileri müşteri temsilcimize iletiniz.

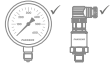
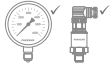
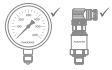
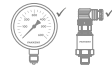
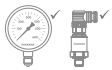
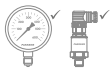
Çalışma Basıncı | Flanş Ölçüleri | Malzeme Detayı | Malzeme Kaplama Detayı* | Akışkan ve Çalışma Sıcaklığı
Diyafram ayırıcılı ürünler, basınç ölçer veya transmitter ile akuple olarak satılmaktadır.Diğer diyafram modelleri için
www.pakkens.com adresini
ziyaret ediniz.**0564**
SOMUN BAĞLANTILI
KONİK YATAKLAMALI
STERİL TİPKomple Paslanmaz
AISI 316L SSBağlantı Tipi No : ----- **01** Alttan Bağlantılı
Bağlantı Tipi No : ----- **04** Arkadan Bağlantılı Eksenden Kaçık**0564**
KAYNAK BOYUNLU
KONİK YATAKLAMALI
STERİL TİPKomple Paslanmaz
AISI 316L SSBağlantı Tipi No : ----- **01** Alttan Bağlantılı
Bağlantı Tipi No : ----- **04** Arkadan Bağlantılı Eksenden Kaçık**0565**
SOMUN BAĞLANTILI
KONİK YATAKLAMALIKomple Paslanmaz
AISI 316L SSBağlantı Tipi No : ----- **01** Alttan Bağlantılı
Bağlantı Tipi No : ----- **04** Arkadan Bağlantılı Eksenden Kaçık**0565**
KAYNAK BOYUNLU
KONİK YATAKLAMALIKomple Paslanmaz
AISI 316L SSBağlantı Tipi No : ----- **01** Alttan Bağlantılı
Bağlantı Tipi No : ----- **04** Arkadan Bağlantılı Eksenden Kaçık**0566 1**
RAKOR BAĞLANTILI
KONİK YATAKLAMALIKomple Paslanmaz
AISI 316L SSBağlantı Tipi No : ----- **01** Alttan Bağlantılı
Bağlantı Tipi No : ----- **04** Arkadan Bağlantılı Eksenden Kaçık**0566 37**
RAKOR BAĞLANTILI
KAYNAK BOYUNLU
KONİK YATAKLAMALIKomple Paslanmaz
AISI 316L SSBağlantı Tipi No : ----- **01** Alttan Bağlantılı
Bağlantı Tipi No : ----- **04** Arkadan Bağlantılı Eksenden Kaçık**0566 94**
FLANŞ RAKOR BAĞLANTILI
KONİK YATAKLAMALIKomple Paslanmaz
AISI 316L SSBağlantı Tipi No : ----- **01** Alttan Bağlantılı
Bağlantı Tipi No : ----- **04** Arkadan Bağlantılı Eksenden Kaçık**0568**
STERİL TİP
KELEPÇE BAĞLANTILIKomple Paslanmaz
AISI 316L SSBağlantı Tipi No : ----- **01** Alttan Bağlantılı
Bağlantı Tipi No : ----- **04** Arkadan Bağlantılı Eksenden Kaçık**0569 00**
STERİL TİP
YÜKSEK BASINÇ
DİYAFRAM GRUBUKomple Paslanmaz
AISI 316L SSBağlantı Tipi No : ----- **01** Alttan Bağlantılı
Bağlantı Tipi No : ----- **04** Arkadan Bağlantılı Eksenden Kaçık**0569 01**
STERİL TİP
YÜKSEK BASINÇ
DİYAFRAM GRUBUKomple Paslanmaz
AISI 316L SSBağlantı Tipi No : ----- **01** Alttan Bağlantılı
Bağlantı Tipi No : ----- **04** Arkadan Bağlantılı Eksenden Kaçık

DİYAFRAM AYIRICILAR

Diyafram ayırıcılı sistem siparişleriniz için aşağıdaki bilgileri müşteri temsilcimize iletiniz.

Çalışma Basıncı | Flanş Ölçüleri | Malzeme Detayı | Malzeme Kaplama Detayı* | Akışkan ve Çalışma Sıcaklığı
Diyafram ayırıcılı ürünler, basınç ölçer veya transmitter ile akuple olarak satılmaktadır.

Diğer diyafram modelleri için
www.pakkens.com adresini
ziyaret ediniz.



0569 02
STERİL TİP
KELEPÇE BAĞLANTILI
YÜKSEK BASINÇ
DİYAFRAM GRUBU
Komple Paslanmaz
AISI 316L SS

Bağlantı Tipi No : - - - - - 01 Alttan Bağlantılı
Bağlantı Tipi No : - - - - - 04 Arkadan Bağlantılı Eksenden Kaçık



0573 0
SOMUN BAĞLANTILI
YÜKSEK BASINÇ
DİYAFRAM GRUBU
Komple Paslanmaz
AISI 316L SS

Bağlantı Tipi No : - - - - - 01 Alttan Bağlantılı
Bağlantı Tipi No : - - - - - 04 Arkadan Bağlantılı Eksenden Kaçık



0573 2
RAKOR BAĞLANTILI,
KONİK YATAKLAMALI
YÜKSEK BASINÇ
DİYAFRAM GRUBU
Komple Paslanmaz
AISI 316L SS

Bağlantı Tipi No : - - - - - 01 Alttan Bağlantılı
Bağlantı Tipi No : - - - - - 04 Arkadan Bağlantılı Eksenden Kaçık

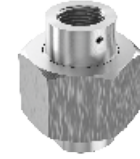

0573 1
SOMUN, RAKOR BAĞLANTILI
YÜKSEK BASINÇ
DİYAFRAM GRUBU
Komple Paslanmaz
AISI 316L SS

Bağlantı Tipi No : - - - - - 01 Alttan Bağlantılı
Bağlantı Tipi No : - - - - - 04 Arkadan Bağlantılı Eksenden Kaçık

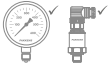

0579
RAKOR BAĞLANTILI
YÜKSEK BASINÇ
DİYAFRAM GRUBU
Komple Paslanmaz
AISI 316L SS

Bağlantı Tipi No : - - - - - 01 Alttan Bağlantılı
Bağlantı Tipi No : - - - - - 04 Arkadan Bağlantılı Eksenden Kaçık



SCHAEFFER TİP

Schaeffer tip siparişleriniz için aşağıdaki bilgileri müşteri temsilcimize iletiniz.

Çalışma Basıncı | Flanş Ölçüleri | Malzeme Kaplama Detayı* | Akışkan ve Çalışma Sıcaklığı

**0504**

0/40...0/400 mbar

0506

0/0,6...0/25 bar

Komple Paslanmaz
316L SS

Vida Bağlantılı

**0524**

0/40...0/400 mbar

0526

0/0,6...0/25 bar

Komple Paslanmaz
316L SS

Flanş Bağlantılı

**0528**

0/40...0/400 mbar

Komple Paslanmaz
316L SS

Flanş Bağlantılı



**0532**

0/0,6...0/25 bar

Komple Paslanmaz
316L SS

Flanş Bağlantılı

* Teflon (PTFE) Kaplama

| MASTAR BASINÇ ÖLÇERLER | | | | | |
|---|--------|--|--|--|-------------------|
| Ø160 | 6 1/2" | MANOMETRE | 0/0,6..1.1,6..2,5..4..6..10..16..25..40..60..100..160..250..400..600 bar | bar | 160 120 01 |
| | IP41 | VAKUMMETRE | -1/0 | bar | 160 120 01 --/025 |
| | | | | Gövde: Metal (Beyaz Boyalı) Kapak: Metal (Bayonet) Basınç Elemanı: Bakır Alaşım Bağlantı Elemanı: Pirinç Mekanizma : Pirinç | |
|  <p>Cl. 0,6 €198,00</p> <p>P-VISION</p> <p>Model No : 160 120 01 Alttan Bağlantılı</p> | |  <p>Cl. 0,25 €245,00</p> <p>P-VISION</p> <p>Model No : 160 120 01 -- /025 Alttan Bağlantılı</p> | |  <p>Kalibrasyon TS EN ISO / IEC 17025 AB-0009-K</p> <p>PAKKENS® KALİBRASYON LABORATUVARI</p> | |

Sipariş verilirken ;

Sıvı veya Gaz ölçüleceği bildirilmelidir. Kadran üzerine “ L (sıvı)” veya “ G (gaz)” harfleri yazılır, buna göre kalibre edilir. Her master basınç ölçerle birlikte, **TÜRKAK (TÜRK AKREDİTASYON KURUMU)** tarafından onaylı basınç laboratuvarımız tarafından “Kalibrasyon Sertifikası (e-sertifika)” verilir.

Not :

Master Basınç Ölçerler, yılda en az bir kez kalibre edilmelidirler. Sık kullanımlarda bu süre daha kısa tutulmalıdır.

| KALİBRASYON TÜRÜ | KLAS* | € |
|------------------------------|-------------|-------|
| Basınç Ölçer Kalibrasyonu | 2,5 | 15,50 |
| Basınç Ölçer Kalibrasyonu | 1,0 - 1,6 | 18,70 |
| Basınç Ölçer Kalibrasyonu | 0,6 | 25,30 |
| Basınç Ölçer Kalibrasyonu | 0,1 - 0,25 | 49,80 |
| Sıcaklık Ölçer Kalibrasyonu* | 2,0 | 18,70 |
| Sıcaklık Ölçer Kalibrasyonu* | 1,0 | 25,30 |
| Basılı Sertifika Fiyat Farkı | Tüm Klaslar | 5,00 |

*Sıcaklık Ölçerler TÜRKAK akreditasyon kapsamı dışında sertifikalandırılmaktadır.

MANİFOLDLAR

1 YOLLU

1 ADET AÇMA - KAPAMA VANASI
1 ADET TAHLİYE TAPASI

Çalışma Basıncı (Azami)
413 bar (6000 psi) / 38°C
Çalışma Sıcaklığı
-54°C / +210°C

**MP1012**

Paslanmaz
316L SS

Fiyat sorunuz.

1/2" NPT Dişi - 1/2" NPT Dişi

**MP1022**

Paslanmaz
316L SS

Fiyat sorunuz.

1/2" NPT Erkek - 1/2" NPT Dişi

**MP1032**

Paslanmaz
316L SS

Fiyat sorunuz.

1/2" NPT Erkek - 1/2" NPT Erkek

**MP1052**

Paslanmaz
316L SS

Fiyat sorunuz.

1/2" NPT Erkek - 1/2" NPT Dişi

**MP1062**

Paslanmaz
316L SS

Fiyat sorunuz.

1/2" NPT Erkek - 1/2" NPT Dişi



2 YOLLU

1 ADET AÇMA - KAPAMA VANASI
1 ADET TAHLİYE VANASI
1 ADET TAHLİYE TAPASI

Çalışma Basıncı (Azami)
413 bar (6000 psi) / 38°C
Çalışma Sıcaklığı
-54°C / +210°C

**MP2012**

Paslanmaz
316L SS

Fiyat sorunuz.

1/2" NPT Dişi - 1/2" NPT Dişi

**MP2022**

Paslanmaz
316L SS

Fiyat sorunuz.

1/2" NPT Erkek - 1/2" NPT Dişi

**MP2032**

Paslanmaz
316L SS

Fiyat sorunuz.

1/2" NPT Erkek - 1/2" NPT Erkek

**MP2072**

Paslanmaz
316L SS

Fiyat sorunuz.

1/2" NPT Dişi - 1/2" NPT Dişi

**MP2082**

Paslanmaz
316L SS

Fiyat sorunuz.

1/2" NPT Erkek - 1/2" NPT Dişi

**MP2092**

Paslanmaz
316L SS

Fiyat sorunuz.

1/2" NPT Dişi - 1/2" NPT Dişi

**MP2102**

Paslanmaz
316L SS

Fiyat sorunuz.

1/2" NPT Dişi - 1/2" NPT Dişi

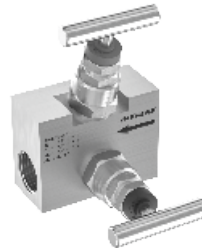
**MP2112**

Paslanmaz
316L SS

Fiyat sorunuz.

1/2" NPT Dişi - 1/2" NPT Dişi



MANİFOLDLAR

3 YOLLU

2 ADET AÇMA - KAPAMA VANASI
1 ADET BİRLEŞTİRME VANASI
2 ADET TAHLİYE TAPASI

Çalışma Basıncı (Azami)
413 bar (6000 psi) / 38°C
Çalışma Sıcaklığı
-54°C / +210°C



MP3092

Paslanmaz
316L SS

Fiyat sorunuz.

1/2" NPT Dişi - 1/2" NPT Dişi

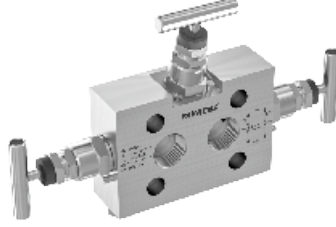

MP3125

Paslanmaz
316L SS

Fiyat sorunuz.

1/2" NPT Dişi - Flanş

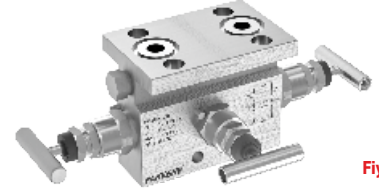

MP3135

Paslanmaz
316L SS

Fiyat sorunuz.

1/2" NPT Dişi - Flanş

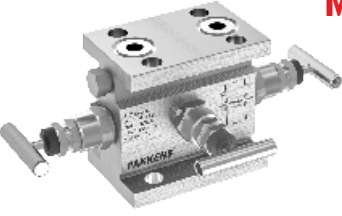

MP3146

Paslanmaz
316L SS

Fiyat sorunuz.

Flanş - Flanş



5 YOLLU

2 ADET AÇMA - KAPAMA VANASI
2 ADET TAHLİYE VANASI
1 ADET BİRLEŞTİRME VANASI
1 ADET TAHLİYE TAPASI

Çalışma Basıncı (Azami)
413 bar (6000 psi) / 38°C
Çalışma Sıcaklığı
-54°C / +210°C

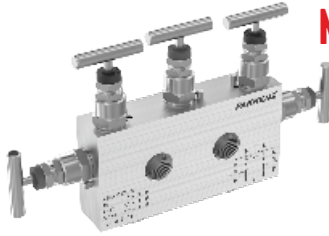

MP5092

Paslanmaz
316L SS

Fiyat sorunuz.

1/2" NPT Dişi - 1/2" NPT Dişi

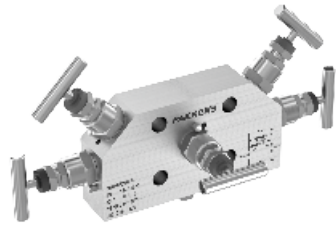

MP5125

Paslanmaz
316L SS

Fiyat sorunuz.

1/2" NPT Dişi - Flanş



MP5135

Paslanmaz
316L SS

Fiyat sorunuz.

1/2" NPT Dişi - Flanş



MP5146

Paslanmaz
316L SS

Fiyat sorunuz.

Flanş - Flanş



AKSESUARLAR VE KORUYUCU EKİPMANLAR

TSEK

MANOMETRE MUSLUĞU

3 Yollu
Manometre Musluğu

G1/2" Dişi - G1/2" Dişi

€10,75

G1/2" Dişi - G1/4" Dişi

€10,75

Pirinç Nikel Kaplamalı

Model No: 91040040400

G1/2" - G1/2"

PN6



Model No: 91040040200

G1/2" - G1/4"

PN6

3 Yollu
Manometre Musluğu

Pirinç - G1/2" - G1/2"

€21,90

Paslanmaz - G1/2" - G1/2"

€48,00

Model No: 91042250400

Pirinç

PN64

5 Ad.

Model No: 91042500000

Paslanmaz

PN64

1 Ad.

2 Yollu
Manometre Musluğu

Pirinç - 1/4" BSPT - G1/4"

€12,45

Paslanmaz - 1/4" BSPT - G1/4"

€35,30

Model No: 91043111100

Pirinç

PN250

5 Ad.

Model No: 91043311100

Paslanmaz

PN250

1 Ad.



Titreşim Kesici

Pirinç - G1/2" - G1/2"

€10,20

Paslanmaz - G1/2" - G1/2"

€15,35

Model No: 91045040401

Pirinç

PN250

5 Ad.

Model No: 91045040407

Paslanmaz

PN400

1 Ad.



Soğutma Kulesi

Pirinç - G1/2" - G1/2"

€10,50

Paslanmaz - G1/2" - G1/2"

€21,80

Model No: 1051040401

Pirinç

PN600

5 Ad.

Model No: 1051040402

Paslanmaz

PN600

1 Ad.



Stoper

Pirinç - 1/2" NPT - G1/4"

€2,10

Model No: 91101000000

25

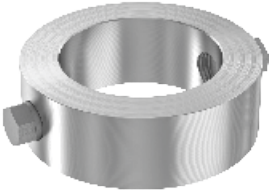

Yıkama Flaşı

Fiyat sorunuz.

Düz tip flaşlı
diyafram ayırıcılı
sistemlerde kullanılır.

Model No: 0522



Adaptörler

Fiyat sorunuz.

Model No: 1050



AKIŞ KIRICI SIFONLAR

U Tipi
Akış Kırıcı Sifon

| Ürün Kodu | Malzeme | Bağlantı | € |
|------------|---------------------|----------------------------|-------|
| 1046040400 | Çelik Ø20 mm | G1/2" Rakor G1/2" Somun | 9,75 |
| 1046200400 | Paslanmaz Ø20 mm | G1/2" Rakor G1/2" Somun | 26,40 |
| 1046900404 | Çelik Ø20 mm | G1/2" Rakor G1/2" Rakor | 9,00 |
| 1046040407 | Paslanmaz Ø20 mm | G1/2" Rakor G1/2" Rakor | 22,00 |

PN100

Çelik: 10 Ad.
Paslanmaz: 1 Ad.90° - O Tipi
Akış Kırıcı Sifon

| Ürün Kodu | Malzeme | Bağlantı | € |
|------------|---------------------|----------------------------|-------|
| 1046701100 | Çelik Ø20 mm | G1/2" Rakor G1/2" Somun | 9,75 |
| 1046241100 | Paslanmaz Ø20 mm | G1/2" Rakor G1/2" Somun | 26,40 |
| 1046791100 | Çelik Ø20 mm | G1/2" Rakor G1/2" Rakor | 9,00 |
| 1046291100 | Paslanmaz Ø20 mm | G1/2" Rakor G1/2" Rakor | 22,00 |

PN100

Çelik: 10 Ad.
Paslanmaz: 1 Ad.180° - O Tipi
Akış Kırıcı Sifon

| Ürün Kodu | Malzeme | Bağlantı | € |
|------------|---------------------|----------------------------|-------|
| 1047040400 | Çelik Ø20 mm | G1/2" Rakor G1/2" Somun | 10,10 |
| 1047200400 | Paslanmaz Ø20 mm | G1/2" Rakor G1/2" Somun | 28,70 |
| 1047900404 | Çelik Ø20 mm | G1/2" Rakor G1/2" Rakor | 10,10 |
| 1047040407 | Paslanmaz Ø20 mm | G1/2" Rakor G1/2" Rakor | 25,60 |

PN100

Çelik: 10 Ad.
Paslanmaz: 1 Ad.



SICAKLIK



SICAKLIK

ÖLÇERLER

| | | | | | | | |
|------------|---------|-------------------|--|----|----------------|---|--|
| Ø63 | Cl. 2,0 | TERMOMETRE | -30...+60*, 0...+120*, 160*, 200*, 250, 300, 350, 400, 500 °C * Sadece 5 cm. için mevcut sıcaklık skalaları | °C | 063 402 | Gövde: AISI 430 SS Kapak: AISI 430 SS Termovil: AISI 316L SS 5 cm termoviller piring üretilir. | |
| | G 1/2" | | | | | | |



| Dalma Boyu | | € |
|------------|--------|--------------|
| * 5 cm | 25 ad. | 3,95 |
| 10 cm | 2 ad. | 6,15 |
| 15 cm | 2 ad. | 7,70 |
| 20 cm | 1 ad. | 8,90 |
| 25 cm | 1 ad. | 9,90 |
| 30 cm | 1 ad. | 10,80 |
| 40 cm | 1 ad. | 13,50 |
| 50 cm | 1 ad. | 16,40 |

Model No: **063 402**
Arkadan Bağlantılı

| | | | | | | | |
|-------------|---------|-------------------|---|----|----------------|---|--|
| Ø100 | Cl. 2,0 | TERMOMETRE | -30...+60, 0...+120, 160, 200, 250, 300, 350, 400, 500 °C -30...+60*, 0...+120*, 160*, 200*, 250, 300, 350, 400, 500 °C * Sadece 5 cm. için mevcut sıcaklık skalaları | °C | 100 401 | Gövde: AISI 430 SS Kapak: AISI 430 SS Termovil: AISI 316L SS 5 cm termoviller piring üretilir. | |
| | G 1/2" | | | | | | |



| Dalma Boyu | | € |
|------------|-------|--------------|
| 10 cm | 4 ad. | 10,30 |
| 15 cm | 2 ad. | 11,55 |
| 20 cm | 2 ad. | 12,95 |
| 25 cm | 1 ad. | 14,15 |
| 30 cm | 1 ad. | 15,40 |
| 40 cm | 1 ad. | 18,00 |
| 50 cm | 1 ad. | 20,75 |
| 70 cm | 1 ad. | 26,15 |
| 100 cm | 1 ad. | 34,35 |

Gövde: Metal (Siyah Boyalı)
Kapak: Metal (Bayonet)

Model No: **100 401**
Alttan Bağlantılı



| Dalma Boyu | | € |
|------------|-------|--------------|
| 5 cm | 6 ad. | 4,95 |
| 10 cm | 4 ad. | 7,45 |
| 15 cm | 2 ad. | 8,95 |
| 20 cm | 2 ad. | 10,15 |
| 25 cm | 2 ad. | 11,15 |
| 30 cm | 1 ad. | 12,15 |
| 40 cm | 1 ad. | 14,80 |
| 50 cm | 1 ad. | 18,15 |
| 70 cm | 1 ad. | 23,45 |
| 100 cm | 1 ad. | 31,90 |

Model No: **100 402**
Arkadan Bağlantılı

| | | | | | | | |
|-------------|---------|-------------------|--|----|----------------|--|--|
| Ø160 | Cl. 2,0 | TERMOMETRE | -30...+60, 0...+120, 160, 200, 250, 300, 350, 400, 500 °C -30...+60, 0...+120, 160, 200, 250, 300, 350, 400, 500 °C | °C | 160 401 | Gövde: Metal (Siyah Boyalı) Kapak: Metal, Bayonet Termovil: AISI 316L SS | |
| | G 1/2" | | | | | | |



| Dalma Boyu | | € |
|------------|-------|--------------|
| 10 cm | 1 ad. | 23,30 |
| 15 cm | 1 ad. | 24,90 |
| 20 cm | 1 ad. | 26,40 |
| 25 cm | 1 ad. | 27,70 |
| 30 cm | 1 ad. | 29,00 |
| 40 cm | 1 ad. | 31,30 |
| 50 cm | 1 ad. | 34,50 |
| 70 cm | 1 ad. | 40,20 |
| 100 cm | 1 ad. | 48,40 |

Model No: **160 401**
Alttan Bağlantılı





| Dalma Boyu | | € |
|------------|-------|--------------|
| 10 cm | 1 ad. | 20,40 |
| 15 cm | 1 ad. | 21,80 |
| 20 cm | 1 ad. | 22,60 |
| 25 cm | 1 ad. | 23,80 |
| 30 cm | 1 ad. | 25,20 |
| 40 cm | 1 ad. | 27,80 |
| 50 cm | 1 ad. | 30,60 |
| 70 cm | 1 ad. | 36,00 |
| 100 cm | 1 ad. | 43,00 |

Model No: **160 402**
Arkadan Bağlantılı

KOMPLE PASLANMAZ

| | | | | | | | |
|------|---------|------------|--|----|---------|--|---|
| Ø100 | Cl. 2,0 | TERMOMETRE | -30...+60, 0...+120, 160, 200, 250, 300, 350, 400, 500 °C Sıkma yüzüklü ürünler için fiyat sorunuz. | °C | 100 411 | Gövde: AISI 304 SS Kapak: AISI 304 SS Termovil: AISI 316L SS |  |
| | G 1/2" | | | | 100 412 | | |
| | IP51 | | | | | | |

| | | |
|---|------------|-------|
|  | Dalma Boyu | € |
| | 10 cm | 19,60 |
| | 15 cm | 21,50 |
| | 20 cm | 23,30 |
| | 25 cm | 25,60 |
| | 30 cm | 27,60 |
| | 40 cm | 31,30 |
| | 50 cm | 34,80 |
| | 70 cm | 42,90 |
| | 100 cm | 54,60 |

| | | |
|--|------------|-------|
|  | Dalma Boyu | € |
| | 10 cm | 19,40 |
| | 15 cm | 21,40 |
| | 20 cm | 22,90 |
| | 25 cm | 24,80 |
| | 30 cm | 26,30 |
| | 40 cm | 30,10 |
| | 50 cm | 34,10 |
| | 70 cm | 42,20 |
| | 100 cm | 53,60 |



| | | | | | | | |
|------|---------|------------|--|----|---------|--|---|
| Ø160 | Cl. 2,0 | TERMOMETRE | -30...+60, 0...+120, 160, 200, 250, 300, 350, 400, 500 °C Sıkma yüzüklü ürünler için fiyat sorunuz. | °C | 160 411 | Gövde: AISI 304 SS Kapak: AISI 304 SS Termovil: AISI 316L SS |  |
| | G 1/2" | | | | 160 412 | | |
| | IP51 | | | | | | |

| | | |
|--|------------|-------|
|  | Dalma Boyu | € |
| | 10 cm | 34,00 |
| | 15 cm | 36,00 |
| | 20 cm | 37,00 |
| | 25 cm | 39,00 |
| | 30 cm | 42,00 |
| | 40 cm | 47,00 |
| | 50 cm | 52,00 |
| | 70 cm | 58,00 |
| | 100 cm | 70,00 |



| | | |
|--|------------|-------|
|  | Dalma Boyu | € |
| | 10 cm | 33,00 |
| | 15 cm | 35,00 |
| | 20 cm | 36,00 |
| | 25 cm | 38,00 |
| | 30 cm | 40,00 |
| | 40 cm | 44,00 |
| | 50 cm | 48,00 |
| | 70 cm | 57,00 |
| | 100 cm | 67,00 |

KOMPLE PASLANMAZ, SIZDIRMAZ TİP

| | | | | | | | | |
|-------------|---------|---------|-------------------|--|----|--------------------|--|--|
| Ø100 | Cl. 2,0 | Cl. 1,0 | TERMOMETRE | -30...+60, 0...+120, 160, 200, 250, 300, 350, 400, 500 °C Sıkma yüzüklü ürünler için fiyat sorunuz. | °C | 100 451 | Gövde: AISI 304 SS Kapak: AISI 304 SS Termovil: AISI 316L SS | |
| | G 1/2" | | | | | 100 851 | | |
| | IP65 | | | | | 100 452 100 852 | | |



| | | | | |
|---|---|------------|---------|---------|
|  Fiyat Sorunuz |  | Dalma Boyu | Cl. 2,0 | Cl. 1,0 |
| | | | € | € |
| | | 10 cm | 27,50 | 32,50 |
| | | 15 cm | 29,80 | 34,80 |
| | | 20 cm | 31,50 | 36,50 |
| | | 25 cm | 33,00 | 38,00 |
| | | 30 cm | 35,00 | 40,00 |
| | | 40 cm | 38,00 | 43,00 |
| | | 50 cm | 43,00 | 48,00 |
| | | 70 cm | 51,00 | 56,00 |
| 100 cm | 62,00 | 67,00 | | |

Model No: 100 451
Alttan Bağlantılı



| | | | | |
|--|--|------------|---------|---------|
|  Fiyat Sorunuz |  | Dalma Boyu | Cl. 2,0 | Cl. 1,0 |
| | | | € | € |
| | | 10 cm | 25,50 | 30,50 |
| | | 15 cm | 27,50 | 32,50 |
| | | 20 cm | 29,40 | 34,40 |
| | | 25 cm | 31,30 | 36,30 |
| | | 30 cm | 33,20 | 38,20 |
| | | 40 cm | 37,00 | 42,00 |
| | | 50 cm | 41,00 | 46,00 |
| | | 70 cm | 48,50 | 53,50 |
| 100 cm | 60,00 | 65,00 | | |

Model No: 100 452
Arkadan Bağlantılı

| | | | | | | | | |
|-------------|---------|---------|-------------------|--|----|--------------------|--|--|
| Ø160 | Cl. 2,0 | Cl. 1,0 | TERMOMETRE | -30...+60, 0...+120, 160, 200, 250, 300, 350, 400, 500 °C Sıkma yüzüklü ürünler için fiyat sorunuz. | °C | 160 451 | Gövde: AISI 304 SS Kapak: AISI 304 SS Termovil: AISI 316L SS | |
| | G 1/2" | | | | | 160 851 | | |
| | IP65 | | | | | 160 452 160 852 | | |



| | | | | |
|---|--|------------|---------|---------|
|  Fiyat Sorunuz |  | Dalma Boyu | Cl. 2,0 | Cl. 1,0 |
| | | | € | € |
| | | 10 cm | 34,70 | 39,70 |
| | | 15 cm | 36,70 | 41,70 |
| | | 20 cm | 38,70 | 43,70 |
| | | 25 cm | 40,60 | 45,60 |
| | | 30 cm | 42,70 | 47,70 |
| | | 40 cm | 46,60 | 51,60 |
| | | 50 cm | 50,60 | 55,60 |
| | | 70 cm | 58,70 | 63,70 |
| 100 cm | 70,70 | 75,70 | | |

Model No: 160 451
Alttan Bağlantılı



| | | | | |
|--|--|------------|---------|---------|
|  Fiyat Sorunuz |  | Dalma Boyu | Cl. 2,0 | Cl. 1,0 |
| | | | € | € |
| | | 10 cm | 32,70 | 37,70 |
| | | 15 cm | 34,70 | 39,70 |
| | | 20 cm | 36,70 | 41,70 |
| | | 25 cm | 38,70 | 43,70 |
| | | 30 cm | 40,70 | 45,70 |
| | | 40 cm | 44,70 | 49,70 |
| | | 50 cm | 48,70 | 53,70 |
| | | 70 cm | 56,70 | 61,70 |
| 100 cm | 68,70 | 73,70 | | |

Model No: 160 452
Arkadan Bağlantılı

| | | | | | | | | |
|----------------------------|---------|---------|-------------------|---|----|--------------------|--|--|
| Ø100 Ø160 | Cl. 2,0 | Cl. 1,0 | TERMOMETRE | -30...+60, 0...+120, 160, 200, 250, 300, 350, 400, 500 °C Stem çapı: 9 mm (Opsiyon: 6, 8, 10 mm) Konum ayarlı ürünler sıkma yüzüklüdür. | °C | 100 453 | Gövde: AISI 304 SS Kapak: AISI 304 SS Stem: AISI 316L SS | |
| | G 1/2" | | | | | 100 853 | | |
| | IP65 | | | | | 160 453 160 853 | | |

| | | | | |
|---|---|------------|---------|---------|
|  Fiyat Sorunuz |  | Dalma Boyu | Cl. 2,0 | Cl. 1,0 |
| | | | € | € |
| | | 10 cm | 61,50 | 66,50 |
| | | 15 cm | 63,50 | 68,50 |
| | | 20 cm | 65,50 | 70,50 |
| | | 25 cm | 67,00 | 72,00 |
| | | 30 cm | 69,00 | 74,00 |
| | | 40 cm | 73,00 | 78,00 |
| | | 50 cm | 76,50 | 81,50 |
| | | 70 cm | 84,00 | 89,00 |
| 100 cm | 95,50 | 100,50 | | |



Model No: 100 453
Konum Ayarlı



| | | | | |
|--|--|------------|---------|---------|
|  Fiyat Sorunuz |  | Dalma Boyu | Cl. 2,0 | Cl. 1,0 |
| | | | € | € |
| | | 10 cm | 68,50 | 73,50 |
| | | 15 cm | 70,50 | 75,50 |
| | | 20 cm | 72,00 | 77,00 |
| | | 25 cm | 74,00 | 79,00 |
| | | 30 cm | 76,00 | 81,00 |
| | | 40 cm | 80,00 | 85,00 |
| | | 50 cm | 83,50 | 88,50 |
| | | 70 cm | 91,50 | 96,50 |
| 100 cm | 103,00 | 108,00 | | |

Model No: 160 453
Konum Ayarlı



KOMPLE PASLANMAZ, SIVI DOLGULU



| | | | | | | | | |
|------|---------|---------|------------|---|----|--------------------|--|---|
| Ø100 | Cl. 2,0 | Cl. 1,0 | TERMOMETRE | -30...+60, 0...+120, 160, 200, 250, 300 °C Sıkma yüzüklü ürünler için fiyat sorunuz. | °C | 100 461 | Gövde: AISI 304 SS Kapak: AISI 304 SS Termovül: AISI 316L SS |  |
| | G 1/2" | | | | | 100 861 | | |
| | IP65 | | | | | 100 462 100 862 | | |

| | | | | |
|--|---|------------|-------------------|---------|
|  Fiyat Sorunuz |  | Dalma Boyu | Cl. 2,0 | Cl. 1,0 |
| | | | € | € |
| | | 10 cm | 38,00 | 43,00 |
| | | 15 cm | 40,00 | 45,00 |
| | | 20 cm | 41,50 | 46,50 |
| | | 25 cm | 43,50 | 48,50 |
| | | 30 cm | 45,50 | 50,50 |
| | | 40 cm | 49,00 | 54,00 |
| | | 50 cm | 53,00 | 58,00 |
| | | 70 cm | 60,50 | 65,50 |
| 100 cm | 71,50 | 76,50 | | |
| 4 Cl. 2,0 8 Cl. 1,0 | Model No: 100 461 | 1 | Alttan Bağlantılı | |



| | | | | |
|---|--|------------|--------------------|---------|
|  Fiyat Sorunuz |  | Dalma Boyu | Cl. 2,0 | Cl. 1,0 |
| | | | € | € |
| | | 10 cm | 36,00 | 41,00 |
| | | 15 cm | 38,00 | 43,00 |
| | | 20 cm | 40,00 | 45,00 |
| | | 25 cm | 41,50 | 46,50 |
| | | 30 cm | 43,50 | 48,50 |
| | | 40 cm | 47,50 | 52,50 |
| | | 50 cm | 51,00 | 56,00 |
| | | 70 cm | 58,00 | 63,00 |
| 100 cm | 69,50 | 74,50 | | |
| 4 Cl. 2,0 8 Cl. 1,0 | Model No: 100 462 | 1 | Arkadan Bağlantılı | |



| | | | | | | | | |
|------|---------|---------|------------|---|----|--------------------|--|---|
| Ø160 | Cl. 2,0 | Cl. 1,0 | TERMOMETRE | -30...+60, 0...+120, 160, 200, 250, 300 °C Sıkma yüzüklü ürünler için fiyat sorunuz. | °C | 160 461 | Gövde: AISI 304 SS Kapak: AISI 304 SS Termovül: AISI 316L SS |  |
| | G 1/2" | | | | | 160 861 | | |
| | IP65 | | | | | 160 462 160 862 | | |

| | | | | |
|--|--|------------|-------------------|---------|
|  Fiyat Sorunuz |  | Dalma Boyu | Cl. 2,0 | Cl. 1,0 |
| | | | € | € |
| | | 10 cm | 71,00 | 76,00 |
| | | 15 cm | 73,00 | 78,00 |
| | | 20 cm | 75,00 | 80,00 |
| | | 25 cm | 77,00 | 82,00 |
| | | 30 cm | 79,00 | 84,00 |
| | | 40 cm | 82,00 | 87,00 |
| | | 50 cm | 86,00 | 91,00 |
| | | 70 cm | 94,00 | 99,00 |
| 100 cm | 105,00 | 110,00 | | |
| 4 Cl. 2,0 8 Cl. 1,0 | Model No: 160 461 | 1 | Alttan Bağlantılı | |

| | | | | |
|---|--|------------|--------------------|---------|
|  Fiyat Sorunuz |  | Dalma Boyu | Cl. 2,0 | Cl. 1,0 |
| | | | € | € |
| | | 10 cm | 72,00 | 77,00 |
| | | 15 cm | 74,00 | 79,00 |
| | | 20 cm | 76,00 | 81,00 |
| | | 25 cm | 78,00 | 83,00 |
| | | 30 cm | 80,00 | 85,00 |
| | | 40 cm | 84,00 | 89,00 |
| | | 50 cm | 88,00 | 93,00 |
| | | 70 cm | 96,00 | 101,00 |
| 100 cm | 108,00 | 113,00 | | |
| 4 Cl. 2,0 8 Cl. 1,0 | Model No: 160 462 | 1 | Arkadan Bağlantılı | |

| | | | | | | | | |
|--------------|---------|---------|------------|--|----|--------------------|--|---|
| Ø100 Ø160 | Cl. 2,0 | Cl. 1,0 | TERMOMETRE | -30...+60, 0...+120, 160, 200, 250, 300 °C Stem çapı: 9 mm [Opsiyon: 6, 8, 10 mm] Konum ayarlı ürünler sıkma yüzüklüdür. | °C | 100 463 | Gövde: AISI 304 SS Kapak: AISI 304 SS Stem: AISI 316L SS |  |
| | G 1/2" | | | | | 100 863 | | |
| | IP65 | | | | | 160 463 160 863 | | |

| | | | | |
|--|---|------------|--------------|---------|
|  Fiyat Sorunuz |  | Dalma Boyu | Cl. 2,0 | Cl. 1,0 |
| | | | € | € |
| | | 10 cm | 75,00 | 80,00 |
| | | 15 cm | 77,00 | 82,00 |
| | | 20 cm | 79,00 | 84,00 |
| | | 25 cm | 81,00 | 86,00 |
| | | 30 cm | 83,00 | 88,00 |
| | | 40 cm | 87,00 | 92,00 |
| | | 50 cm | 91,00 | 96,00 |
| | | 70 cm | 99,00 | 104,00 |
| 100 cm | 111,00 | 116,00 | | |
| 4 Cl. 2,0 8 Cl. 1,0 | Model No: 100 463 | 1 | Konum Ayarlı | |

| | | | | |
|---|--|------------|--------------|---------|
|  Fiyat Sorunuz |  | Dalma Boyu | Cl. 2,0 | Cl. 1,0 |
| | | | € | € |
| | | 10 cm | 110,00 | 115,00 |
| | | 15 cm | 112,00 | 117,00 |
| | | 20 cm | 114,00 | 119,00 |
| | | 25 cm | 116,00 | 121,00 |
| | | 30 cm | 118,00 | 123,00 |
| | | 40 cm | 122,00 | 127,00 |
| | | 50 cm | 126,00 | 131,00 |
| | | 70 cm | 133,00 | 138,00 |
| 100 cm | 145,00 | 150,00 | | |
| 4 Cl. 2,0 8 Cl. 1,0 | Model No: 160 463 | 1 | Konum Ayarlı | |

Ø100
Ø160

Cl. 2,0

G 1/2" TERMOMETRE

IP51

-40...+40, 0...+120, 160, 200, 250, 300, 350 °C

°C

100 511

100 512

160 511

160 512

Gövde: AISI 304 SS

Kapak: AISI 304 SS

Bulb: AISI 316L SS



| Model No. | Kapiler | € |
|-----------|---------|--------------|
| 100 511 | 3 mt. | 79,00 |
| 100 512 | | |
| 100 511 | 5 mt. | 98,00 |
| 100 512 | | |

Model No: **100 511**

Alttan Çıkış - Arkadan Flanşlı

Model No: **100 512**

Arkadan Çıkışlı - Önden Flanşlı



| Model No. | Kapiler | € |
|-----------|---------|---------------|
| 160 511 | 3 mt. | 92,00 |
| 160 512 | | |
| 160 511 | 5 mt. | 112,00 |
| 160 512 | | |

Model No: **160 511**

Alttan Çıkış - Arkadan Flanşlı

Model No: **160 512**

Arkadan Çıkışlı - Önden Flanşlı



HASSAS

Ø100
Ø160

CL. 1,0

G 1/2" TERMOMETRE

IP51

-40...+60, 0...+120, 160, 200, 250, 300, 350, 400, 500 °C

°C

100 611

100 612

160 611

160 612

Gövde: AISI 304 SS

Kapak: AISI 304 SS

Bulb: AISI 316L SS



Model No: 100 611

Alttan Çıkış - Arkadan Flanşlı

Model No: 100 612

Arkadan Çıkışlı - Önden Flanşlı



| Model No. | Kapiler | € |
|-----------|---------|--------|
| 100 611 | 3 mt. | 132,00 |
| 100 612 | | |
| 100 611 | 5 mt. | 158,00 |
| 100 612 | | |



Model No: 160 611

Alttan Çıkış - Arkadan Flanşlı

Model No: 160 612

Arkadan Çıkışlı - Önden Flanşlı



| Model No. | Kapiler | € |
|-----------|---------|--------|
| 160 611 | 3 mt. | 144,00 |
| 160 612 | | |
| 160 611 | 5 mt. | 170,00 |
| 160 612 | | |

HASSAS, SIZDIRMAZ

Ø100
Ø160

CL. 1,0

G 1/2" TERMOMETRE

IP65

-40...+60, 0...+120, 160, 200, 250, 300, 350, 400, 500 °C

°C

100 651

100 652

160 651

160 652

Gövde: AISI 304 SS

Kapak: AISI 304 SS

Bulb: AISI 316L SS



Model No: 100 651

Alttan Çıkış - Arkadan Flanşlı

Model No: 100 652

Arkadan Çıkışlı - Önden Flanşlı



Fiyat Sorunuz

| Model No. | Kapiler | € |
|-----------|---------|--------|
| 100 651 | 3 mt. | 151,00 |
| 100 652 | | |
| 100 651 | 5 mt. | 178,00 |
| 100 652 | | |



Model No: 160 651

Alttan Çıkış - Arkadan Flanşlı

Model No: 160 652

Arkadan Çıkışlı - Önden Flanşlı



Fiyat Sorunuz

| Model No. | Kapiler | € |
|-----------|---------|--------|
| 160 651 | 3 mt. | 163,00 |
| 160 652 | | |
| 160 651 | 5 mt. | 190,00 |
| 160 652 | | |

HASSAS, DOLGULU

Ø100
Ø160

CL. 1,0

G 1/2" TERMOMETRE

IP65

-40...+60, 0...+120, 160, 200, 250, 300, 350, 400, 500 °C

°C

100 661

100 662

160 661

160 662

Gövde: AISI 304 SS

Kapak: AISI 304 SS

Bulb: AISI 316L SS



Model No: 100 661

Alttan Çıkış - Arkadan Flanşlı

Model No: 100 662

Arkadan Çıkışlı - Önden Flanşlı



Fiyat Sorunuz

| Model No. | Kapiler | € |
|-----------|---------|--------|
| 100 661 | 3 mt. | 162,00 |
| 100 662 | | |
| 100 661 | 5 mt. | 188,00 |
| 100 662 | | |



Model No: 160 661

Alttan Çıkış - Arkadan Flanşlı

Model No: 160 662

Arkadan Çıkışlı - Önden Flanşlı



Fiyat Sorunuz

| Model No. | Kapiler | € |
|-----------|---------|--------|
| 160 661 | 3 mt. | 200,00 |
| 160 662 | | |
| 160 661 | 5 mt. | 227,00 |
| 160 662 | | |

| | | | | | | | | | | |
|------------|-------------------|----------------------------------|--------------------------|----|----------------|--|---|-----------------------|---------------------------------|----|
| Ø60 | Cl. 2,0 | -30...+60, 0...+120, 160, 200 °C | Kapiler borusu PVC kaplı | °C | 060 522 | Gövde: Metal (Siyah Boyalı) Kapak: AISI 430 SS Termovil: Piriç |  | | | |
| | G 3/8" TERMOMETRE | | | | | | | 0...+250, 300, 350 °C | Kapiler borusu paslanmaz örgülü | °C |
| | IP51 | | | | | | | | | |

Microtac®



| Kontakt | Kapiler | € |
|----------------------|--------------------------------|--------------|
| TK (NC/NO) | 2 mt. PVC kaplı | 47,40 |
| | Kapiler ilavesi (1 mt için) | 1,80 |

Model No: **060 522**
Arkadan Bağlantılı Pano Tip



TK: NO - NC | ÇK: NCNO - NONC - NONO-NCNC

STANDART, KOMPLE PASLANMAZ

| | | | | | | | |
|----------------------|-------------------|---|----|--|--|---|--|
| Ø100 Ø160 | Cl. 2,0 | -40...+40, 0...+120, 160, 200, 250, 300, 350 °C | °C | <input type="checkbox"/> 100 511 <input type="checkbox"/> 100 512 <input type="checkbox"/> 160 511 <input type="checkbox"/> 160 512 | Gövde: AISI 304 SS Kapak: AISI 304 SS Bulb: AISI 316L SS |  | |
| | G 1/2" TERMOMETRE | | | | | | |
| | IP51 | | | | | | |



| Model No. | Kapiler | Kontakt | € |
|-----------|---------|-----------|---------------|
| 100 511 | 3 mt. | TK | 142,00 |
| 100 512 | | ÇK | 162,00 |
| 100 511 | 5 mt. | TK | 161,00 |
| 100 512 | | ÇK | 181,00 |

Model No: **100 511**
Alttan Çıkış - Arkadan Flanşlı

Model No: **100 512**
Arkadan Çıkışlı - Önden Flanşlı



| Model No. | Kapiler | Kontakt | € |
|-----------|---------|-----------|---------------|
| 160 511 | 3 mt. | TK | 155,00 |
| 160 512 | | ÇK | 175,00 |
| 160 511 | 5 mt. | TK | 174,00 |
| 160 512 | | ÇK | 194,00 |

Model No: **160 511**
Alttan Çıkış - Arkadan Flanşlı

Model No: **160 512**
Arkadan Çıkışlı - Önden Flanşlı



HASSAS

TK: NO - NC | ÇK: NCNO - NONC - NONO-NCNC

Ø100
Ø160Cl. 1,0
G 1/2"
IP51

TERMOMETRE

-40...+60, 0...+120, 160, 200, 250, 300, 350, 400, 500 °C

°C

100 611
100 612
160 611
160 612 Gövde: AISI 304 SS
Kapak: AISI 304 SS
Bulb: AISI 316L SS

| Model No. | Kapiler | Kontakt | € |
|-----------|---------|---------|--------|
| 100 611 | 3 mt. | TK | 194,00 |
| 100 612 | | ÇK | 215,00 |
| 100 611 | 5 mt. | TK | 221,00 |
| 100 612 | | ÇK | 241,00 |

Model No: 100 611
Alttan Çıkış - Arkadan FlanşlıModel No: 100 612
Arkadan Çıkışlı - Önden Flanşlı

| Model No. | Kapiler | Kontakt | € |
|-----------|---------|---------|--------|
| 160 611 | 3 mt. | TK | 206,00 |
| 160 612 | | ÇK | 227,00 |
| 160 611 | 5 mt. | TK | 233,00 |
| 160 612 | | ÇK | 253,00 |

Model No: 160 611
Alttan Çıkış - Arkadan FlanşlıModel No: 160 612
Arkadan Çıkışlı - Önden Flanşlı

HASSAS, SIZDIRMAZ

TK: NO - NC | ÇK: NCNO - NONC - NONO-NCNC

Ø100
Ø160Cl. 1,0
G 1/2"
IP65

TERMOMETRE

-40...+60, 0...+120, 160, 200, 250, 300, 350, 400, 500 °C

°C

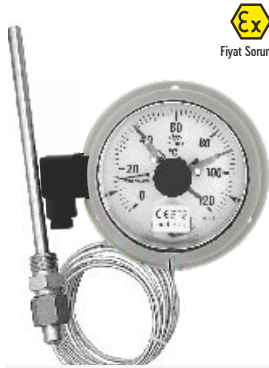
100 651
100 652
160 651
160 651 Gövde: AISI 304 SS
Kapak: AISI 304 SS
Bulb: AISI 316L SS

Fiyat Sorunuz

| Model No. | Kapiler | Kontakt | € |
|-----------|---------|---------|--------|
| 100 651 | 3 mt. | TK | 214,00 |
| 100 652 | | ÇK | 234,00 |
| 100 651 | 5 mt. | TK | 240,00 |
| 100 652 | | ÇK | 260,00 |

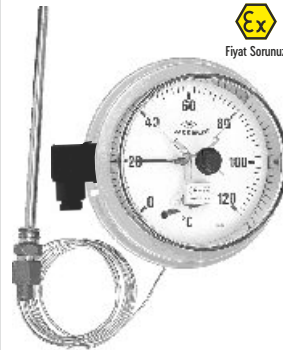
Model No: 100 651
Alttan Çıkış - Arkadan FlanşlıModel No: 100 652
Arkadan Çıkışlı - Önden Flanşlı

Fiyat Sorunuz

| Model No. | Kapiler | Kontakt | € |
|-----------|---------|---------|--------|
| 160 651 | 3 mt. | TK | 226,00 |
| 160 652 | | ÇK | 246,00 |
| 160 651 | 5 mt. | TK | 252,00 |
| 160 652 | | ÇK | 272,00 |

Model No: 160 651
Alttan Çıkış - Arkadan FlanşlıModel No: 160 652
Arkadan Çıkışlı - Önden Flanşlı

HASSAS, DOLGULU

TK: NO - NC | ÇK: NCNO - NONC - NONO-NCNC

Ø100
Ø160Cl. 1,0
G 1/2"
IP65

TERMOMETRE

-40...+60, 0...+120, 160, 200, 250, 300, 350, 400, 500 °C

°C

100 661
100 662
160 661
160 661 Gövde: AISI 304 SS
Kapak: AISI 304 SS
Bulb: AISI 316L SS

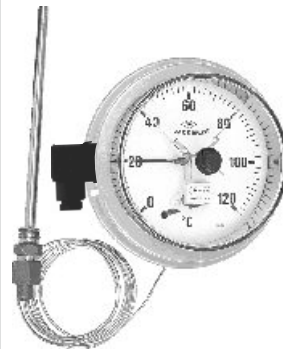

| Model No. | Kapiler | Kontakt | € |
|-----------|---------|---------|--------|
| 100 661 | 3 mt. | TK | 224,00 |
| 100 662 | | ÇK | 245,00 |
| 100 661 | 5 mt. | TK | 251,00 |
| 100 662 | | ÇK | 271,00 |

Model No: 100 661
Alttan Çıkış - Arkadan FlanşlıModel No: 100 662
Arkadan Çıkışlı - Önden Flanşlı

| Model No. | Kapiler | Kontakt | € |
|-----------|---------|---------|--------|
| 160 661 | 3 mt. | TK | 263,00 |
| 160 662 | | ÇK | 283,00 |
| 160 661 | 5 mt. | TK | 289,00 |
| 160 662 | | ÇK | 310,00 |

Model No: 160 661
Alttan Çıkış - Arkadan FlanşlıModel No: 160 662
Arkadan Çıkışlı - Önden Flanşlı

GENEL AMAÇLI

| | | | | | | | |
|--------------------|---------|-------------------|-------------|----|----------------|---|--|
| Ø40 Ø50 | Cl. 2,0 | TERMOMETRE | 0...+120 °C | °C | 040 502 | Gövde: Plastik Kapak: Akrilik Bulb: Bakır |   |
| | IP41 | | | | 050 502 | | |



| Kapiler |  | € |
|---------|---|-------------|
| 1 mt | 20 ad. | 4,50 |
| 3 mt | 10 ad. | 5,65 |

Model No: **040 502**
Arkadan Bağlantılı Pano Tip



| Kapiler |  | € |
|---------|---|-------------|
| 1 mt | 20 ad. | 4,05 |
| 3 mt | 10 ad. | 5,20 |

Model No: **050 502**
Arkadan Bağlantılı Pano Tip

| | | | | | | | | |
|------------|---------|-------------------|----------------------------------|---------------------------------|----|----------------|---|--|
| Ø60 | Cl. 2,0 | TERMOMETRE | -40...+40, 0...+120, 160, 200 °C | Kapiler borusu PVC kaplı | °C | 060 502 | Gövde: AISI 430 SS Kapak: AISI 430 SS Bulb: Bakır |   |
| | IP41 | | 0...+250, 300, 350 °C | Kapiler borusu paslanmaz örgülü | °C | | | |



| Kapiler | € |
|---------------------------|-------------|
| 1 mt. PVC kaplı | 6,70 |
| 1 mt. Paslanmaz örgülü | 7,75 |
| 2 mt. PVC kaplı | 7,40 |
| 2 mt. Paslanmaz örgülü | 8,95 |

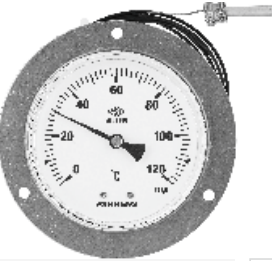

Model No: **060 502**
Arkadan Bağlantılı Pano Tip

| | | | | | | | | |
|-------------|---------|-------------------|----------------------------------|--------------------------|---------------------------------|----------------|---|--|
| Ø100 | Cl. 2,0 | TERMOMETRE | -40...+40, 0...+120, 160, 200 °C | Kapiler borusu PVC kaplı | °C | 100 532 | Gövde: AISI 304 SS Kapak: Akrilik Bulb: Bakır |   |
| | G 1/4" | | IP41 | 0...+250, 300, 350 °C | Kapiler borusu paslanmaz örgülü | | | |



| Kapiler | € |
|---------------------------------|--------------|
| 2 mt. PVC kaplı | 19,05 |
| Kapiler İlavesi (1 mt. için) | 0,70 |
| 2 mt. Paslanmaz örgülü | 22,20 |
| Kapiler İlavesi (1 mt. için) | 1,20 |

Model No: **100 532**
Arkadan Bağlantılı - Önden Flaşlı

| | | | | | | | |
|------------------------|---------|-------------------|------------------------|----|----------------|---|--|
| 58x25 62x12 | Cl. 2,0 | TERMOMETRE | -40...+40, 0...+120 °C | °C | 058 502 | Gövde: Plastik Kapak: Akrilik Bulb: Bakır |   |
| | IP41 | | | | 062 502 | | |



| Kapiler | € |
|---------|-------------|
| 1 mt | 5,20 |
| 3 mt | 6,60 |

Model No: **058 502**
Arkadan Bağlantılı Pano Tip



| Kapiler | € |
|---------|-------------|
| 1 mt | 4,50 |
| 3 mt | 5,90 |

Model No: **062 502**
Arkadan Bağlantılı Pano Tip

KOMBİNE ÖLÇERLER

| | | | | | | | | |
|------------|--------|---------------|-------------|------------|----------|---------|---|-----------|
| Ø40 Ø50 | G 1/4" | KOMBİNE ÖLÇER | 0...+120 °C | 0/4, 6 bar | °C / bar | 040 702 | Gövde: Plastik Kapak: Akrilik Bağlantı Elemanı: Pirinç Basınç Elemanı: Bakır Alaşımı Mekanizma: Pirinç Bulb: Bakır | TSC PC |
| | IP41 | | 0...+120 °C | 0/4, 6 bar | °C / bar | 050 702 | | |



| | |
|---------|-------|
| Kapiler | € |
| 1 mt. | 11,45 |

Model No: 040 702

Arkadan Bağlantılı Pano Tip



| | |
|---------|-------|
| Kapiler | € |
| 1 mt. | 12,95 |

Model No: 050 702

Arkadan Bağlantılı Pano Tip



| | | | | | | | | |
|------|--------|---------------|-------------|-----------------------|----------|------------|--|-----------|
| Ø100 | G 1/2" | KOMBİNE ÖLÇER | 0...+120 °C | 0/4, 6, 10,16, 25 bar | °C / bar | 100 700 01 | Gövde: Metal (Siyah Boyalı) Kapak: Akrilik Bağlantı Elemanı: Pirinç Basınç Elemanı: Bakır Alaşımı Mekanizma: Pirinç Sıcaklık Elemanı Kılıfı: Pirinç | TSC PC |
| | IP41 | | | | | | | |



€13,30

Model No: 100 700 01

Alttan Bağlantılı



REGÜLATÖR

| | | | | |
|--------------------------------------|---------|------------|--|-----------|
| KATI YAKIT TERMOSTATİK REGÜLATÖRÜ | 30/90°C | 079 000 10 | Bağlantı Dişi : G3/4" Gövde (Proses Bağlantısı): Pirinç Ayar Kapağı: Plastik Çalışma Pozisyonu: Dikey, Yatay, Dikey Yan. | TSC PC |
|--------------------------------------|---------|------------|--|-----------|



€13,65

STANDART TERMOVİLLER

TER

G 1/2" TERMOVİL

TER

Malzeme: AISI 316L SS
Termovil Çapı: Ø12 mm
Termovil İç Delik Çapı: Ø10 mm

| Ürün Kodu | Dalma Boyu (mm) | € |
|---------------|-----------------|-------|
| 0510 (Pirinç) | 50 | 1,85 |
| 0520 | 50 | 4,20 |
| 1020 | 100 | 4,60 |
| 1520 | 150 | 4,85 |
| 2020 | 200 | 5,40 |
| 2520 | 250 | 6,20 |
| 3020 | 300 | 7,35 |
| 4020 | 400 | 9,45 |
| 5020 | 500 | 11,60 |
| 7020 | 700 | 15,90 |
| 9920 | 1000 | 20,90 |

Model No: TER
Vida Bağlantılı

ÖZEL TERMOVİLLER

TER

TERMOVİL

Özel termovil talepleriniz için, talep ettiğiniz termovil ölçülerini içeren teknik resim ile satış departmanımızla iletişime geçebilirsiniz.

Malzeme: AISI 316L SS



Diş Bağlantılı



Bar Stock, Kaynaklı Tip



Flanş Bağlantılı

Fiyatlarımıza K.D.V. dahil değildir.

Ödeme vadesi 60 (altmış) gündür.

Bu fiyat listesi en güncel bilgileri sunmaktadır.



PAKKENS mamullerin ve fiyatların üzerinde önceden bildirmeden her türlü değişiklik yapma hakkını saklı tutar.



PAKKENS®

PAKKENS A.Ş.

Organize Sanayi Bölgesi
Sarı Cadde No: 20 Nilüfer
16159 Bursa / Türkiye

 www.pakkens.com
 +90 224 6000 200
 +90 224 6000 230



Where Pressure Matters...™